

ARTECO

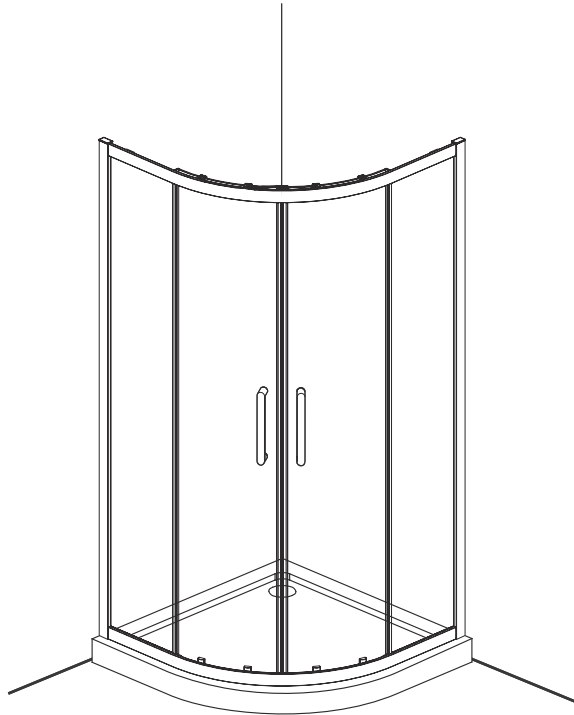

PL INSTRUKCJA MONTAŻU I EKSPLOATACJI

CZ NÁVOD NA MONTÁŽ A ÚDRŽBU

SK NÁVOD NA MONTÁŽ A ÚDRŽBU

EST PAIGALDUS- JA KASUTUSJUHEND

LT MONTAVIMO IR EKSPLOATAVIMO INSTRUKCIJA

LV MONTĀŽAS UN EKSPLUATĀCIJAS INSTRUKCIJA

DE MONTAGE- UND AUFBAUANLEITUNG

RO INSTRUCȚIUNI DE MONTAJ ȘI OPERARE

HU SZERELÉSI ÉS ÜZEMELTETÉSI ÚTMUTATÓ

UA ІНСТРУКЦІЯ З МОНТАЖУ І ЕКСПЛУАТАЦІЇ

BY ІНСТРУКЦЫЯ ПА МАНТАЖЫ І ЭКСПЛУАТАЦЫІ

RU ИНСТРУКЦИЯ ПО МОНТАЖУ И ЭКСПЛУАТАЦИИ

EN INSTRUCTIONS FOR ASSEMBLY AND USE

FR INSTALLATION ET UTILISATION - MODE

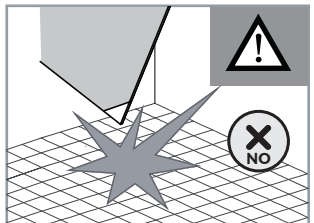
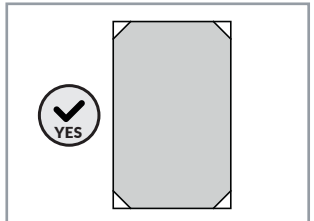
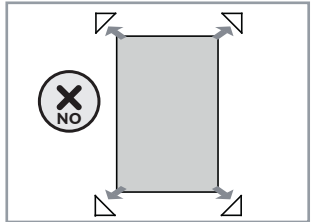
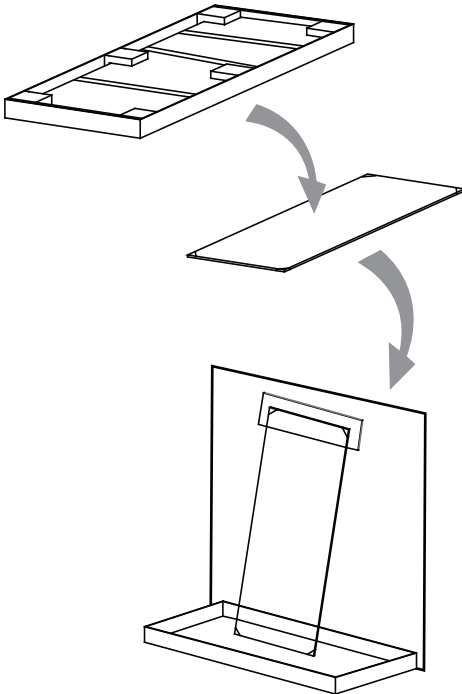
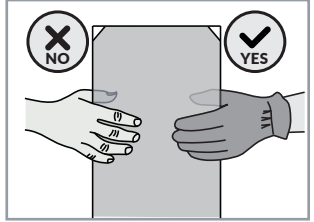
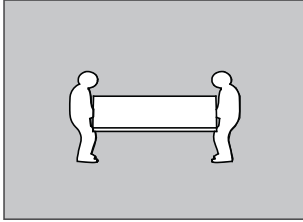
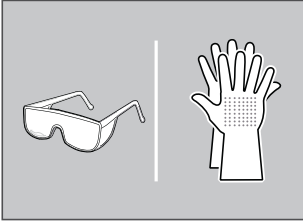
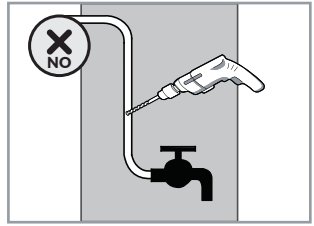
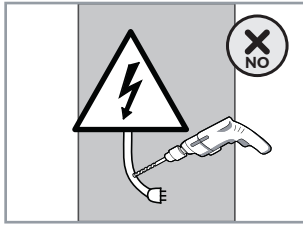
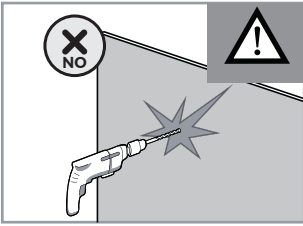

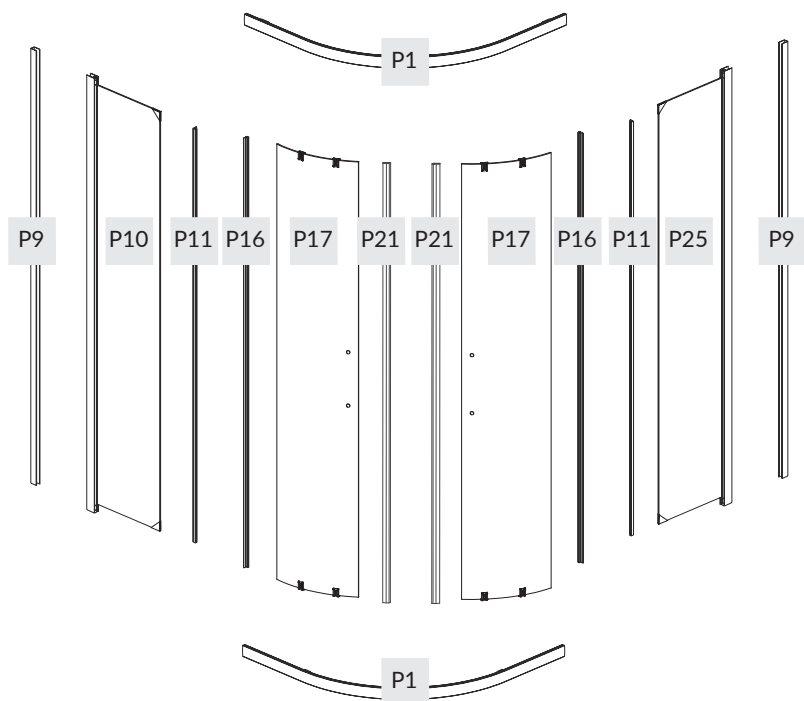

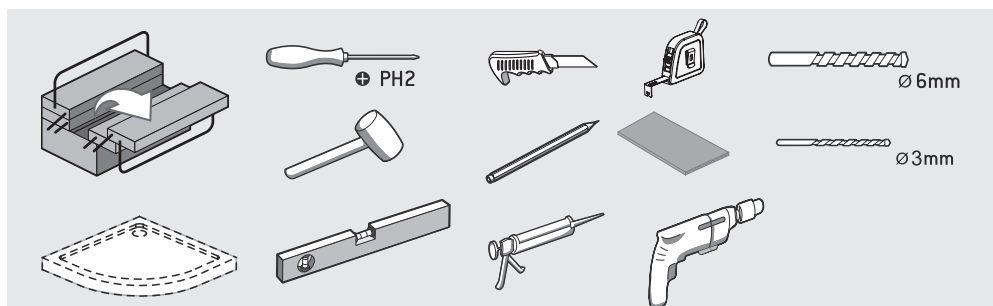
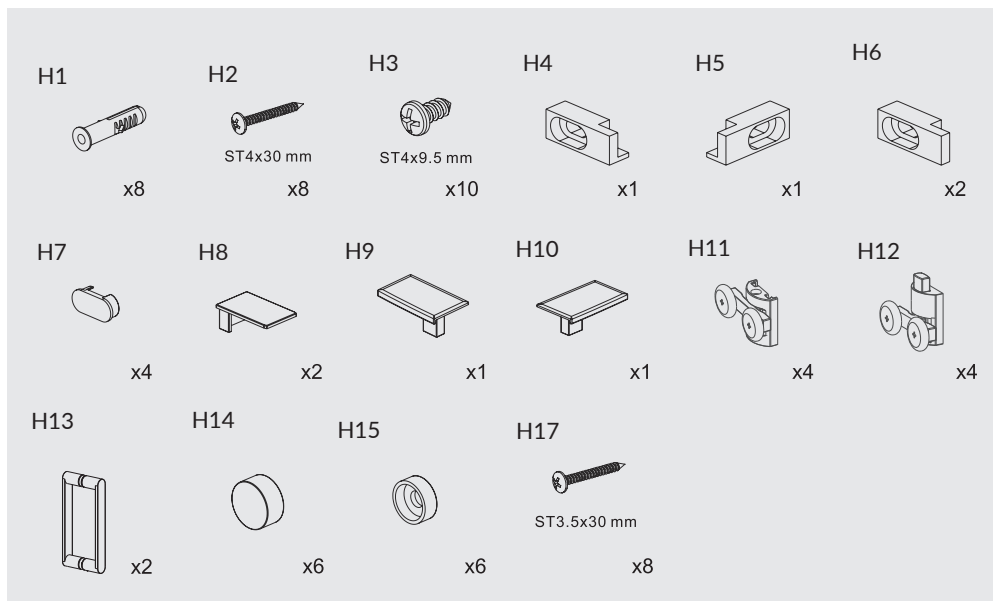

1.

SIZE(mm)	X(mm)	Y (mm)
800x800	783-798	783-798
900x900	883-898	883-898

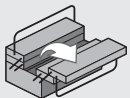
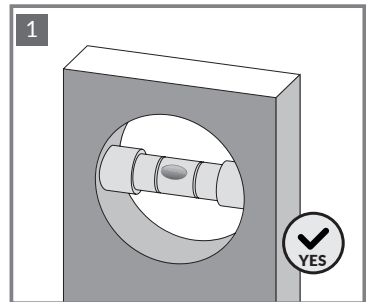
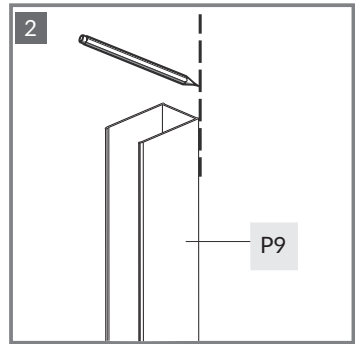
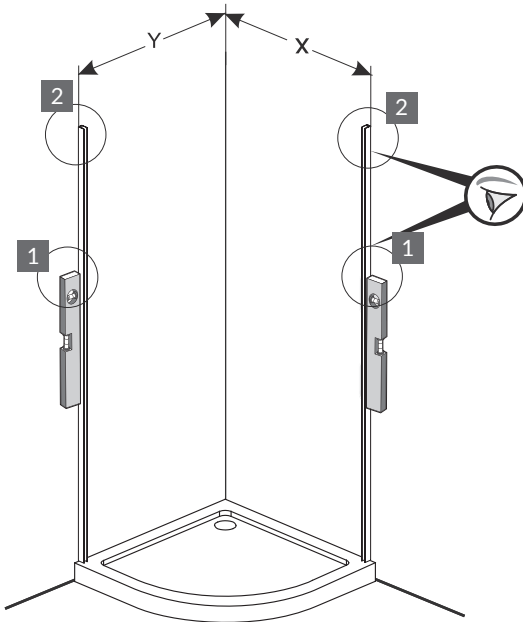

P9

x2



2.

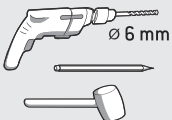
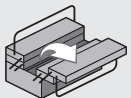
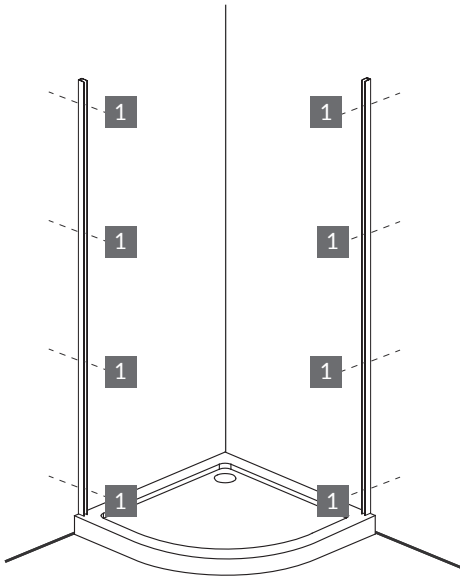
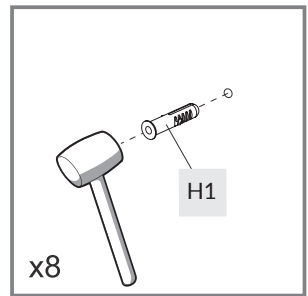
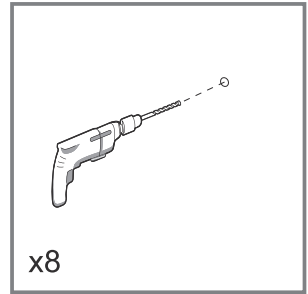
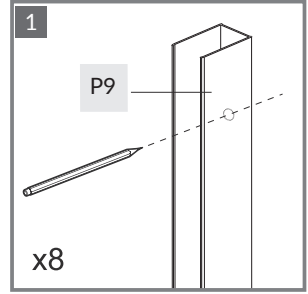
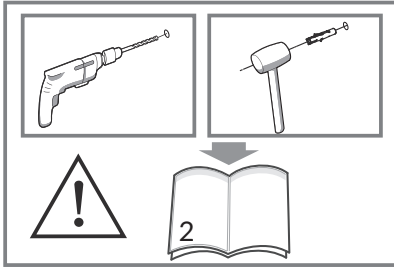

P9  x2

H1  x8



3.

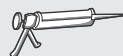
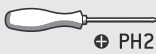
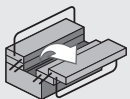
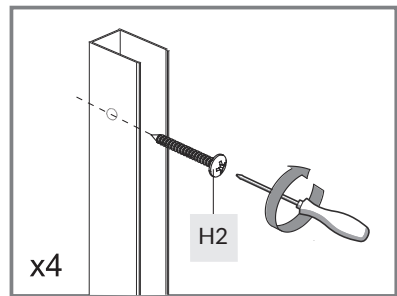
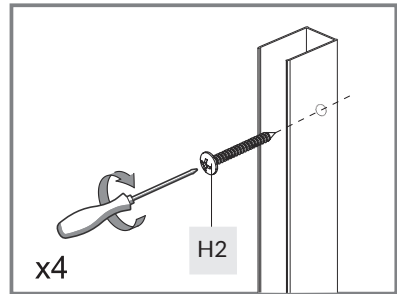
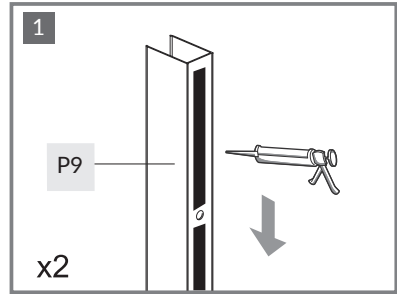
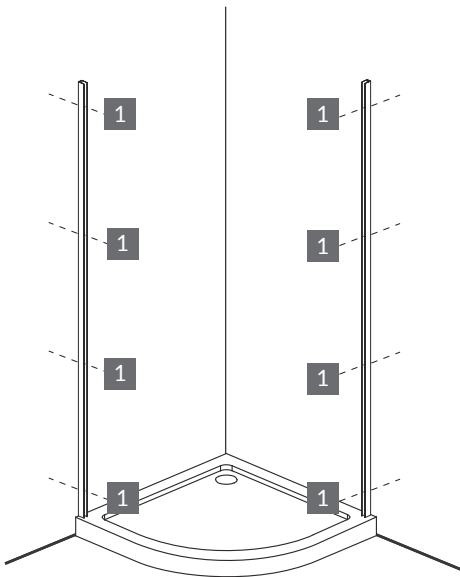

4.

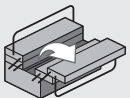
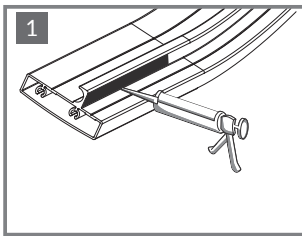
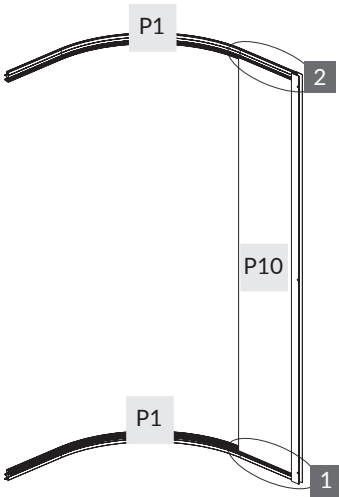
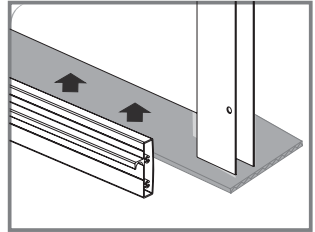
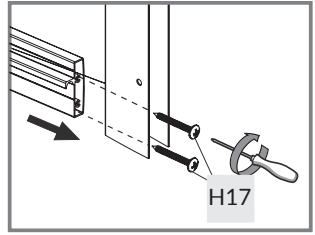
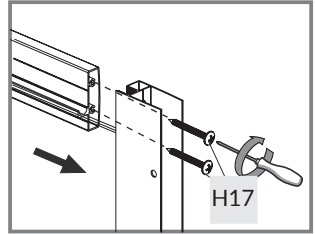
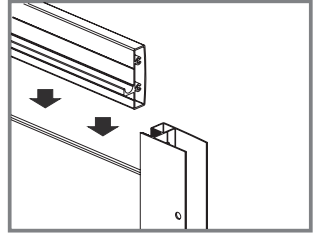
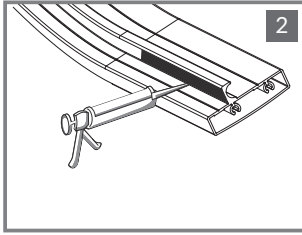

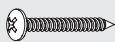
H17  x4



5.

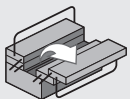
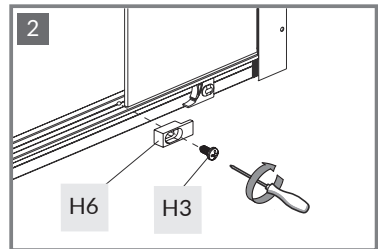
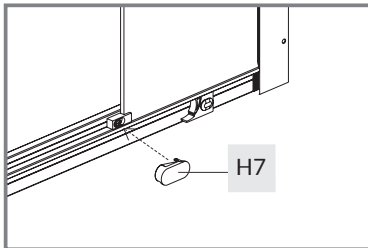
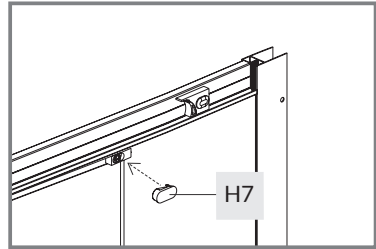
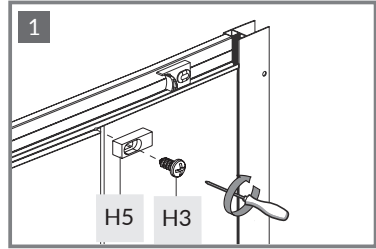
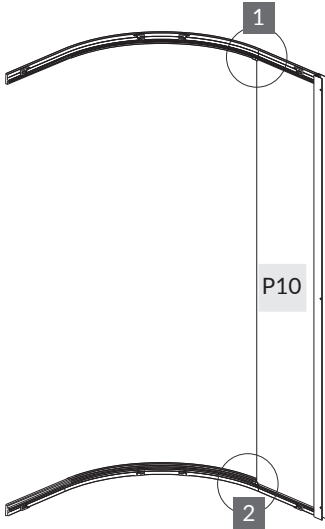

H3  x2

H6  x1

H5  x1

H7  x2



6.

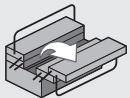
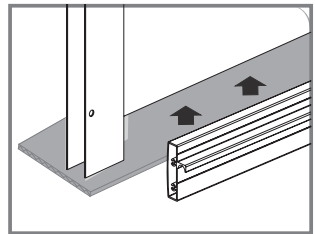
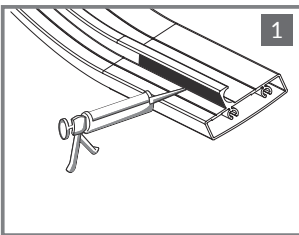
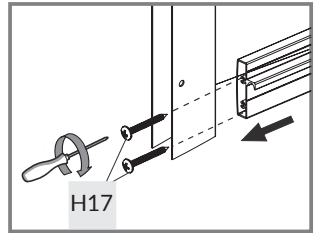
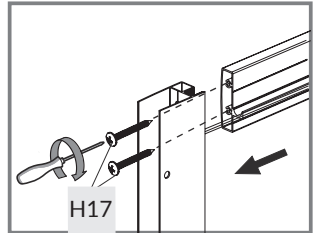
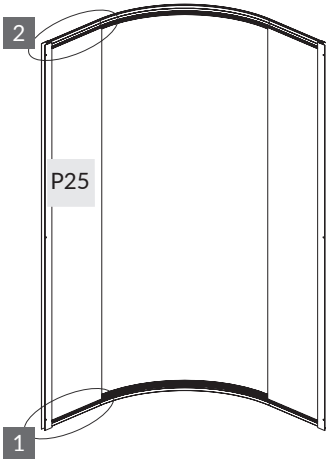
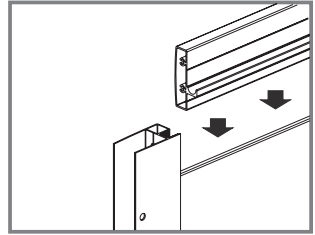
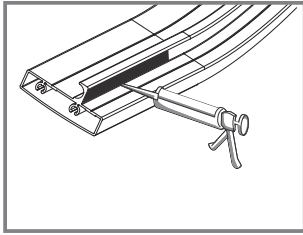

H17

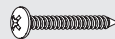

x4



7.

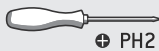
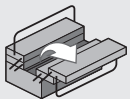
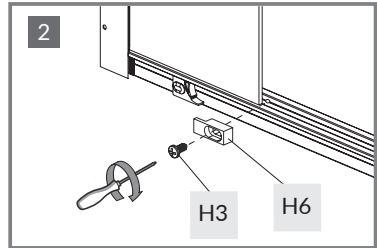
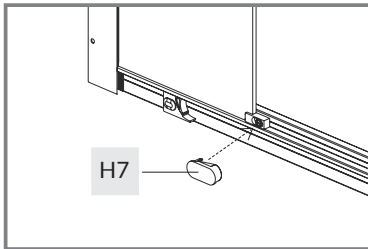
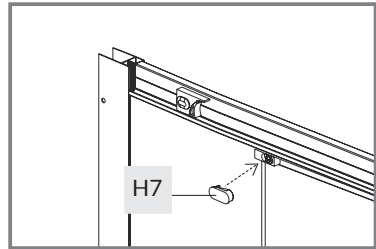
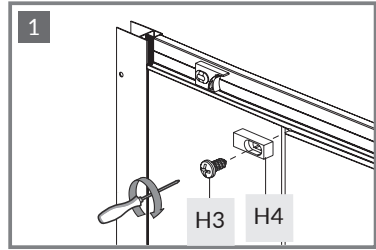
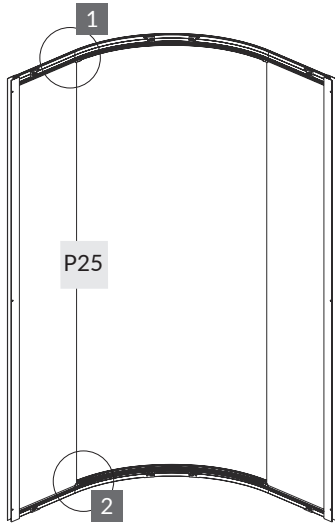

H3 x2



H6 x1



H4 x1



H7 x2



8.

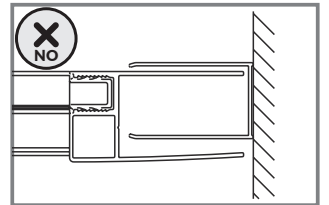
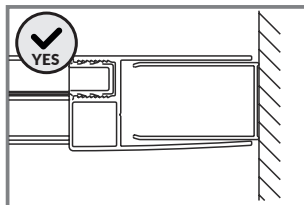
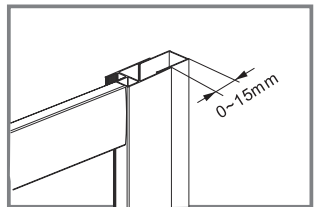
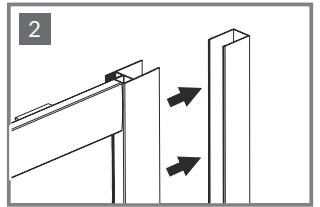
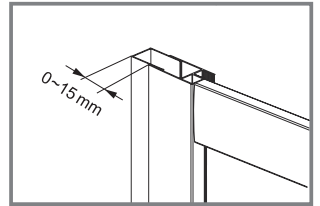
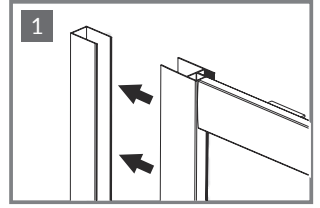
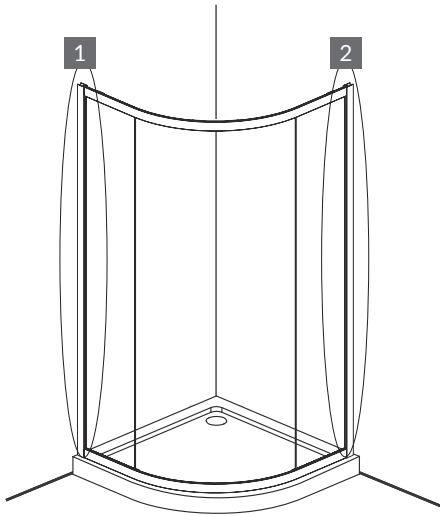

9.

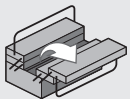
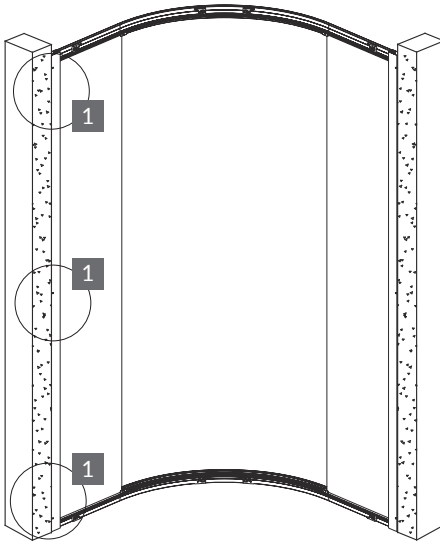
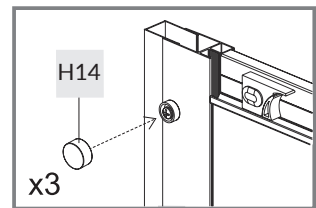
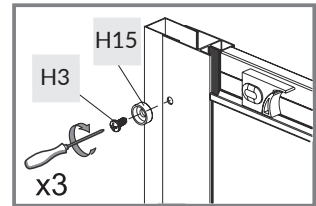
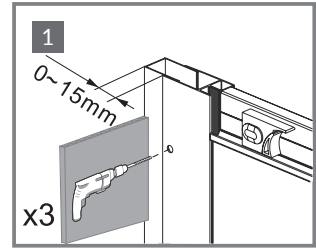
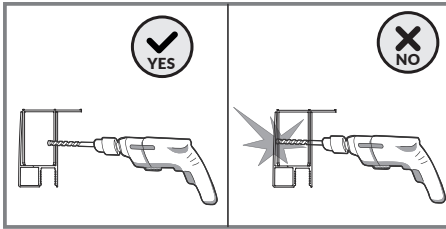

H3  x3

H14  x3

H15  x3



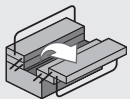
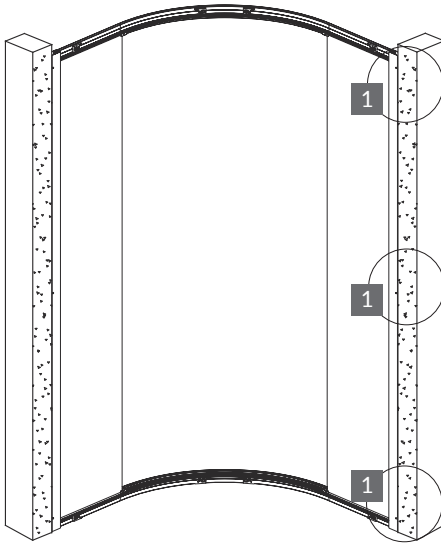
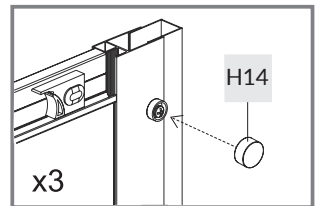
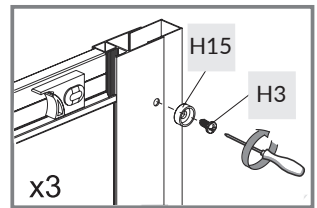
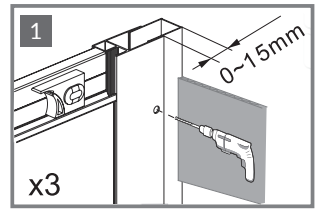
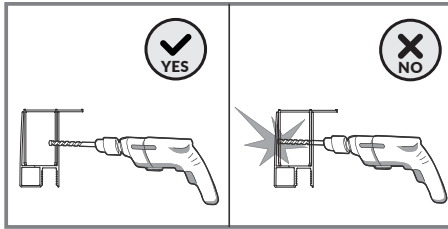

H3  x3

H14  x3

H15  x3



11.

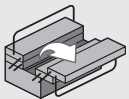
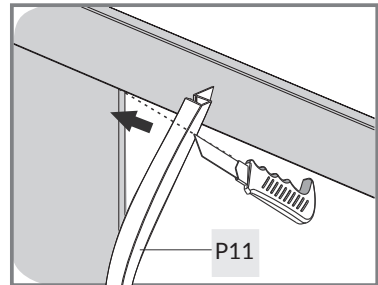
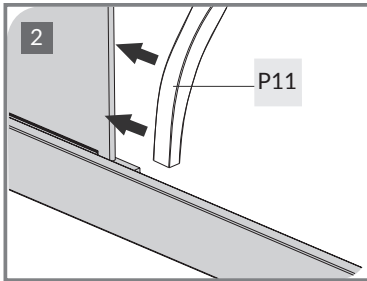
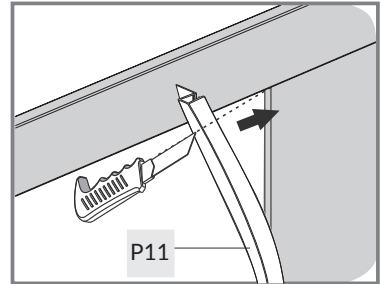
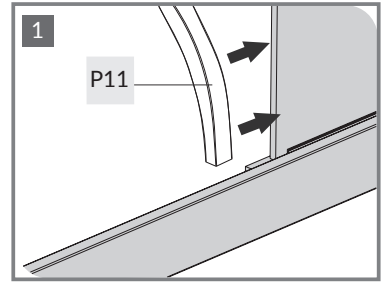
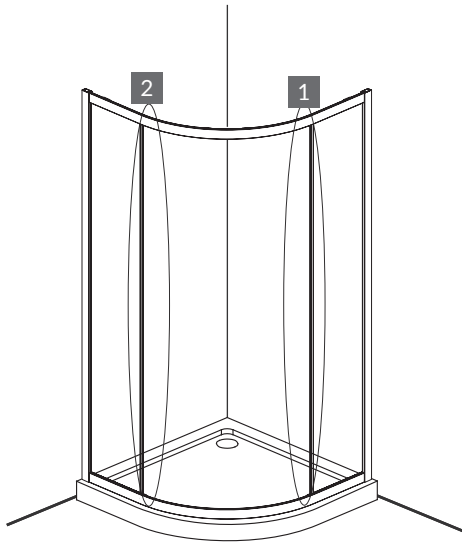

P11

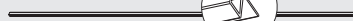

x2



12.

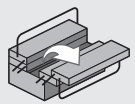
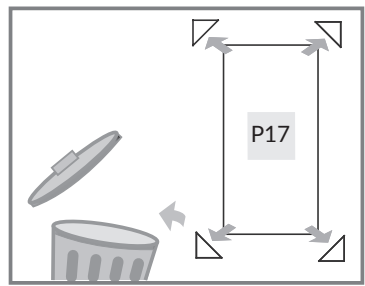
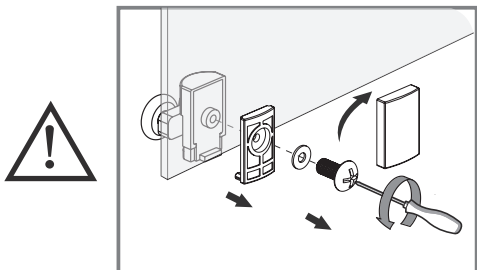
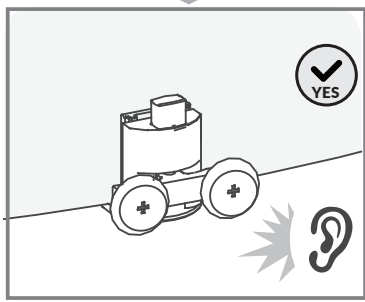
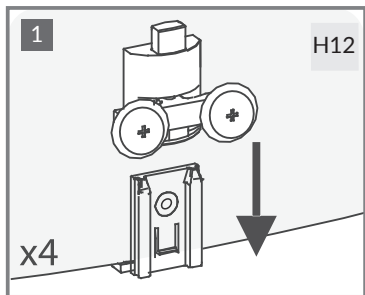
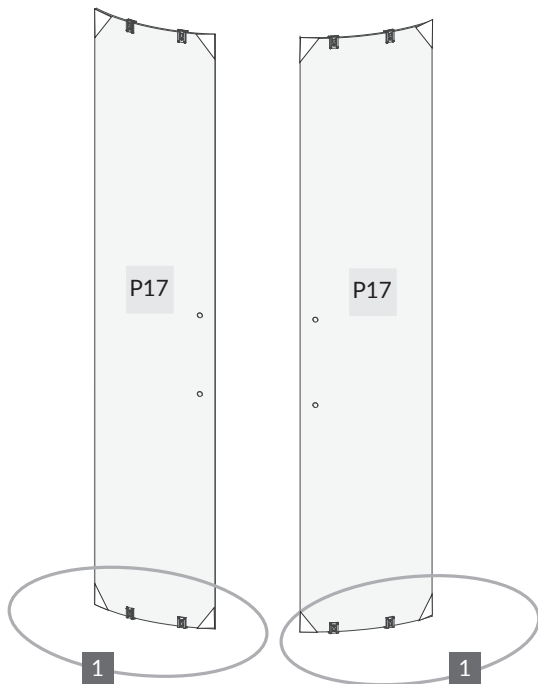

H12



x4



13.

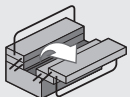
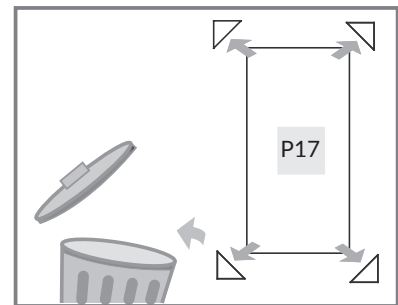
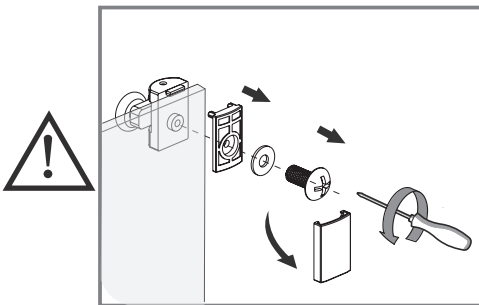
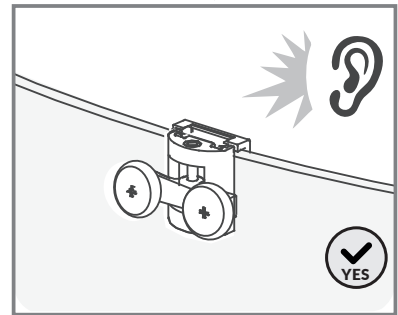
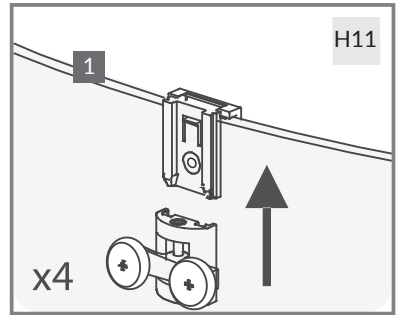
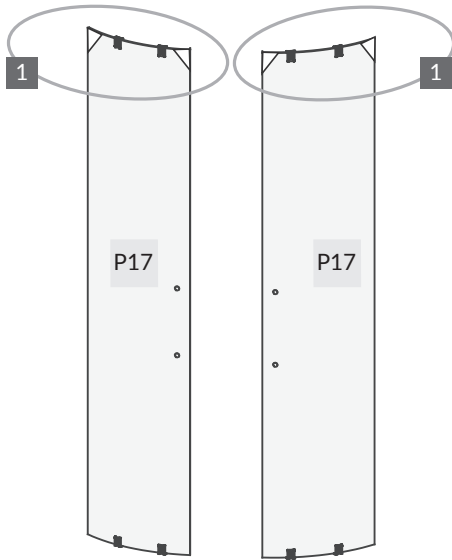

H11



x4



14.

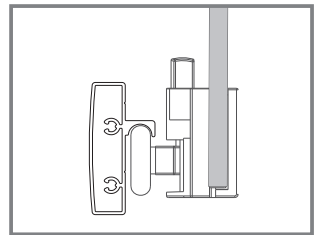
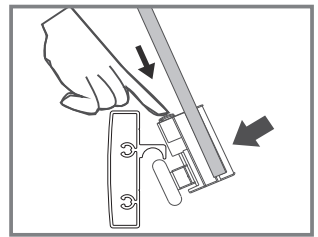
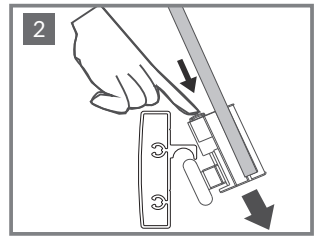
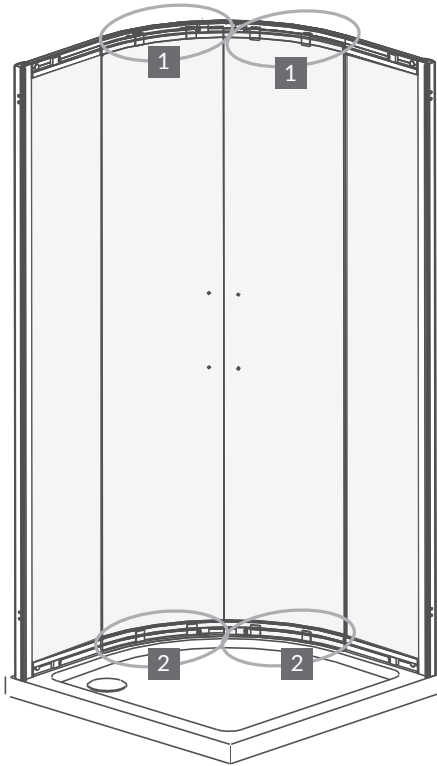
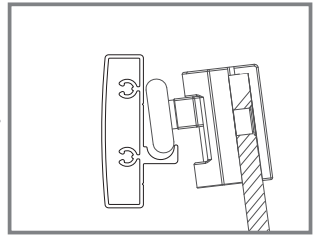
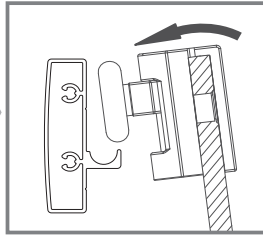
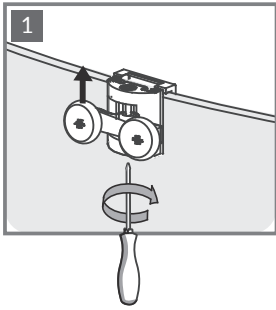

15.

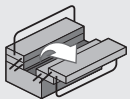
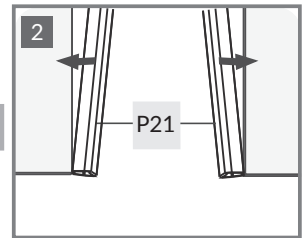
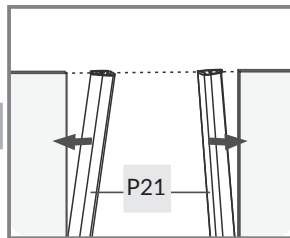
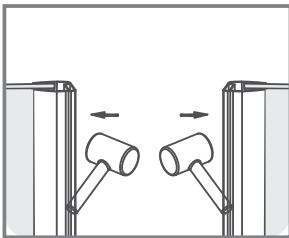
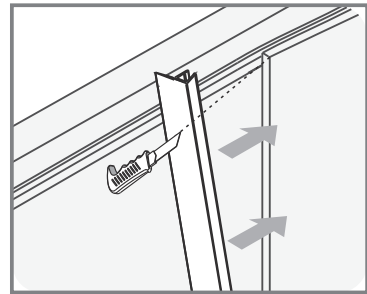
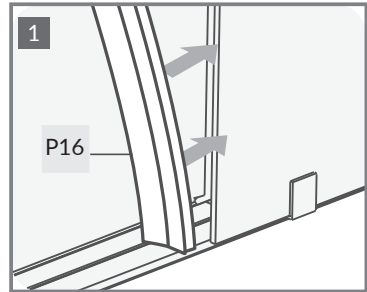
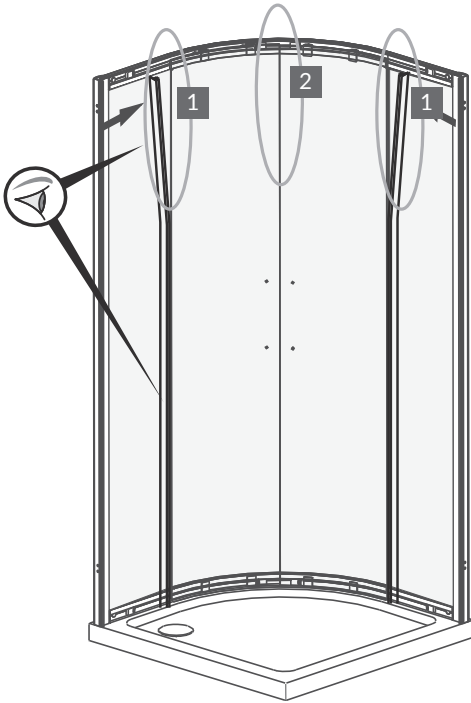

P16  x2

P21  x2



16.

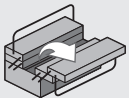
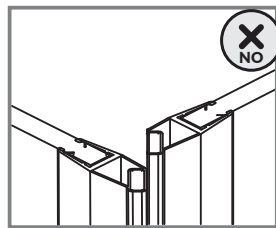
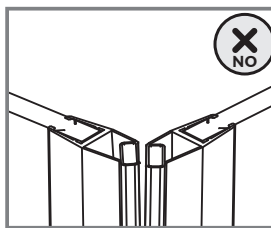
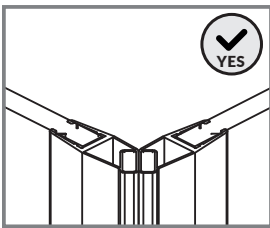
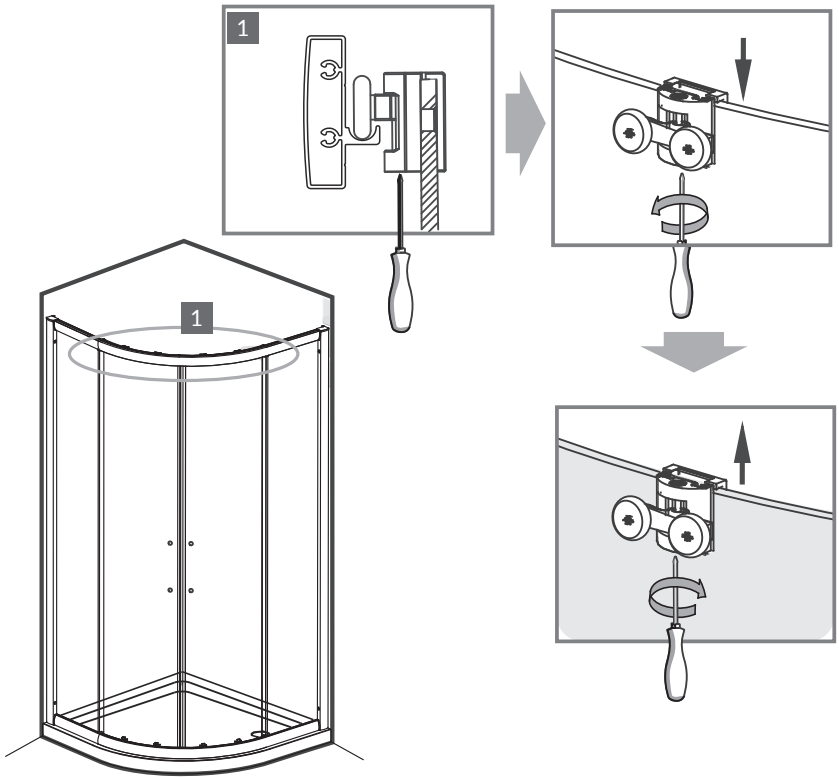

➕ PH2



17.

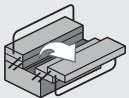
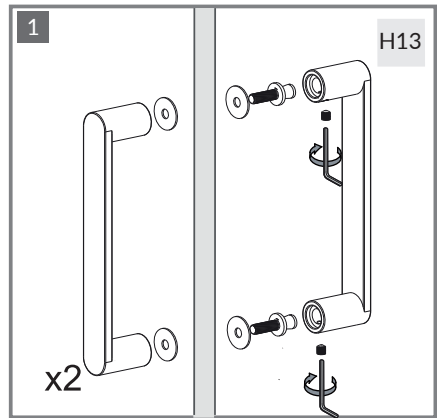
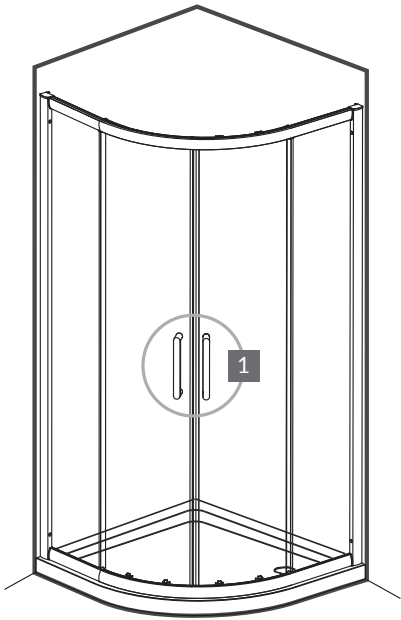

H13

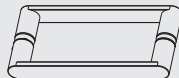

x2



18.

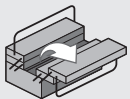
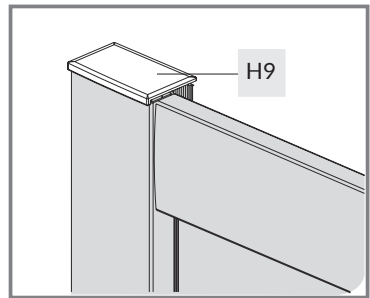
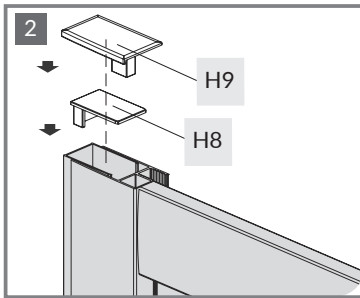
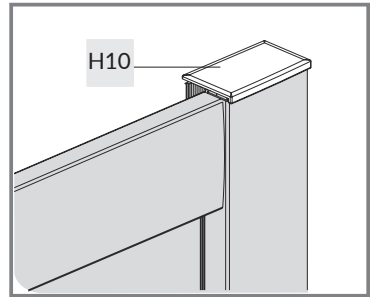
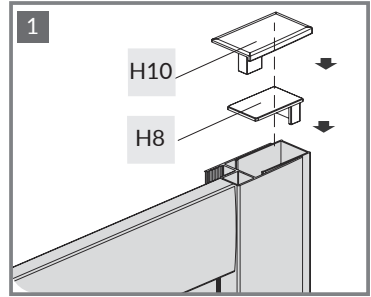
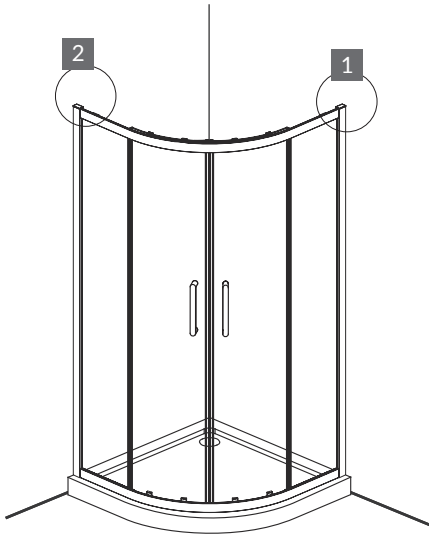

H8



x2

H9



x1

H10



x1



19.

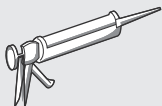
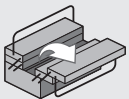
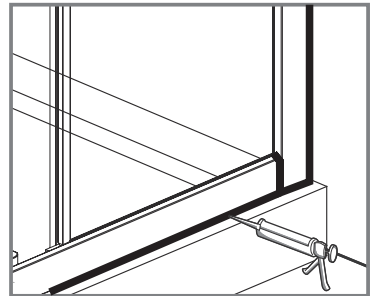
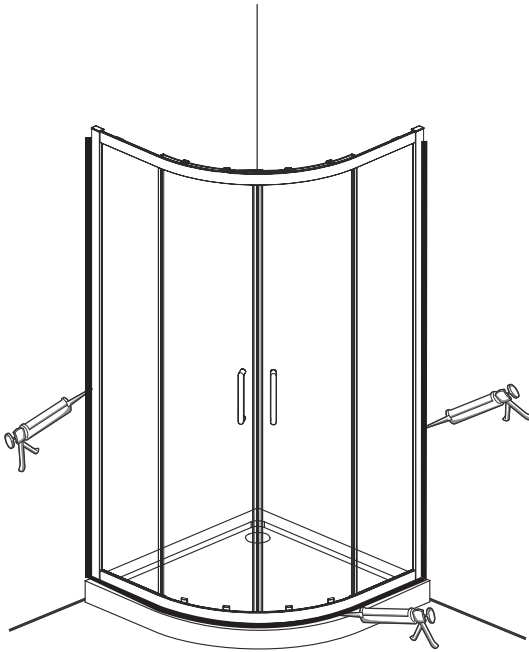



6.5<PH<7.5

