

ARTECO

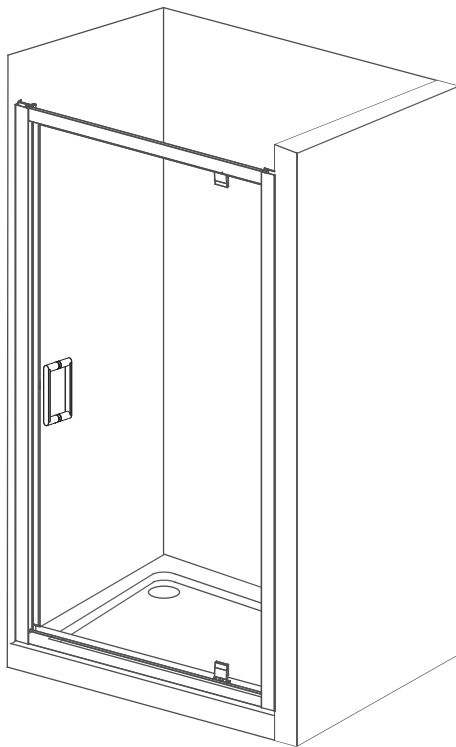

PL INSTRUKCJA MONTAŻU I EKSPLOATACJI

CZ NÁVOD NA MONTÁŽ A ÚDRŽBU

SK NÁVOD NA MONTÁŽ A ÚDRŽBU

EST PAIGALDUS- JA KASUTUSJUHEND

LT MONTAVIMO IR EKSPLOATAVIMO INSTRUKCIJA

LV MONTĀŽAS UN EKSPLUATĀCIJAS INSTRUKCIJA

DE MONTAGE- UND AUFBAUANLEITUNG

RO INSTRUCȚIUNI DE MONTAJ ȘI OPERARE

HU SZERELÉSI ÉS ÜZEMELTETÉSI ÚTMUTATÓ

UA ІНСТРУКЦІЯ З МОНТАЖУ І ЕКСПЛУАТАЦІЇ

BY ІНСТРУКЦЫЯ ПА МАНТАЖЫ І ЭКСПЛУАТАЦЫІ

RU ИНСТРУКЦИЯ ПО МОНТАЖУ И ЭКСПЛУАТАЦИИ

EN INSTRUCTIONS FOR ASSEMBLY AND USE

FR INSTALLATION ET UTILISATION - MODE

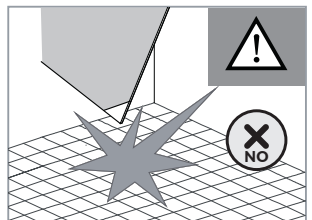
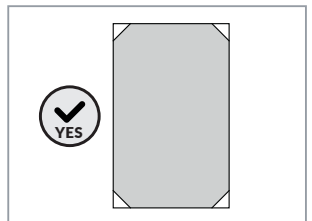
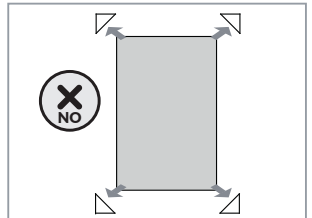
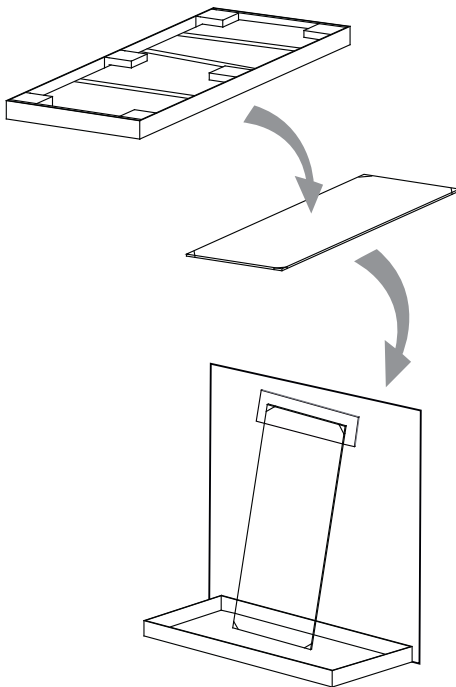
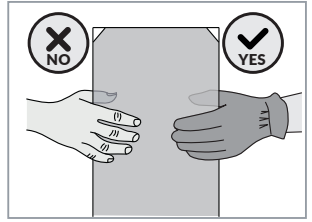
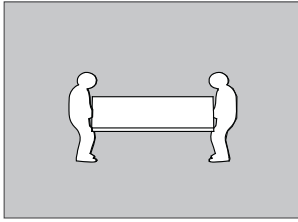
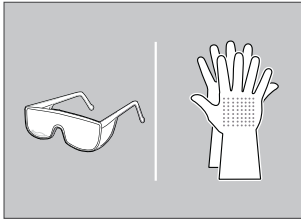
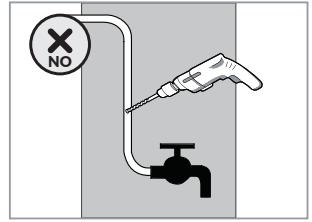
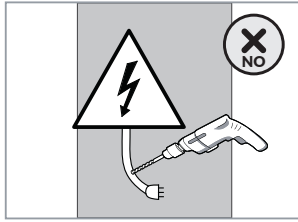
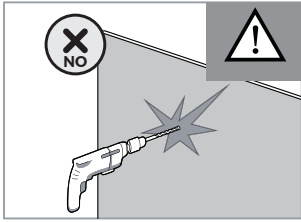

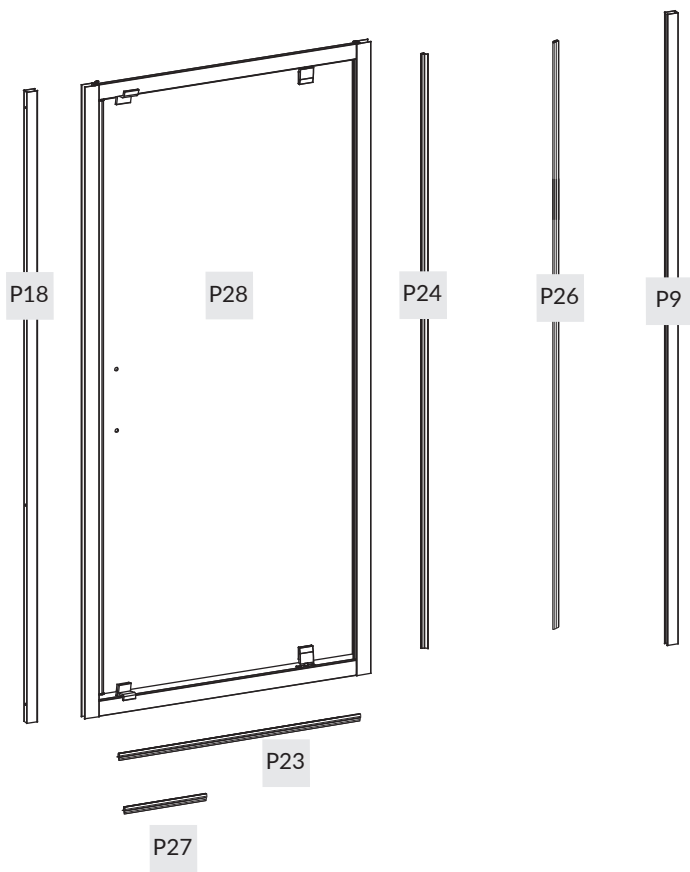



H1



x8

H2



ST4x45mm

x8

H3



ST4x9.5mm

x6

H8



x2

H9



x1

H10



x1

H13



x1

H14



x6

H15



x6

H24



x4

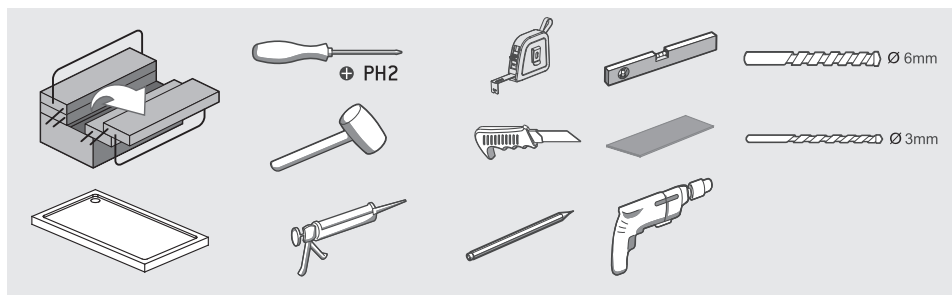

1.

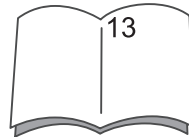
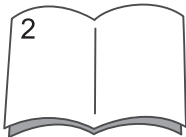
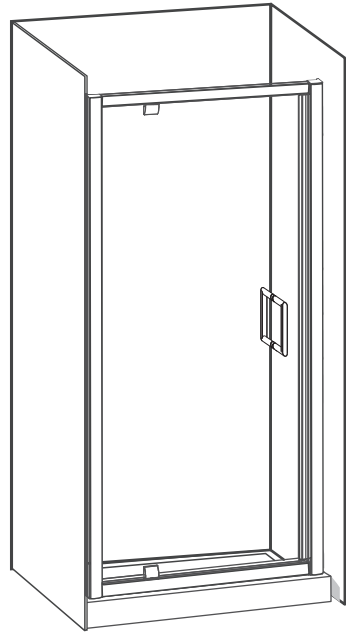
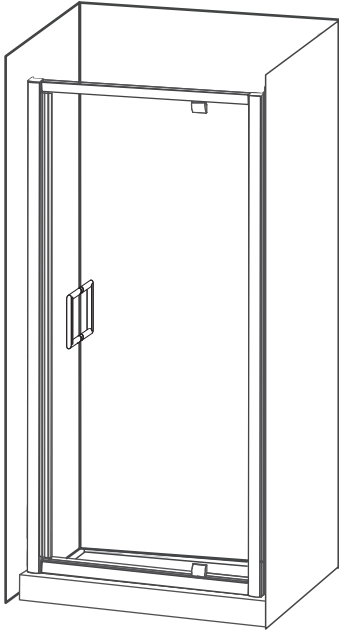

2.



| SIZE | X(mm) |
|------------|---------|
| 700X1900mm | 670-700 |
| 800X1900mm | 770-800 |
| 900X1900mm | 870-900 |

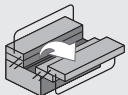
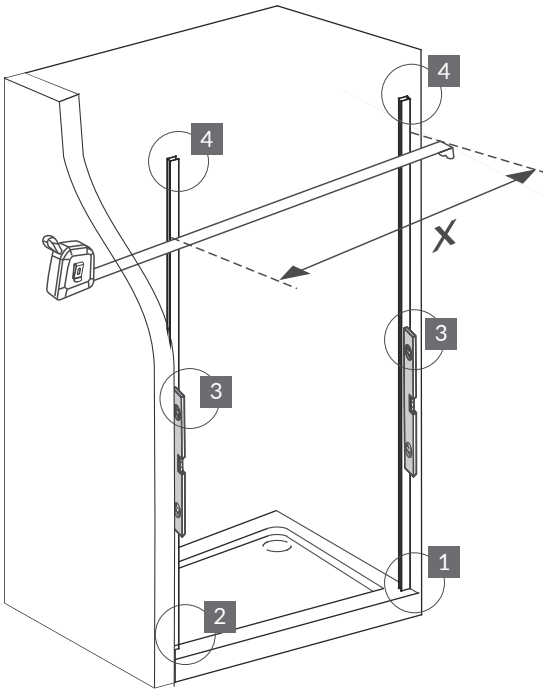
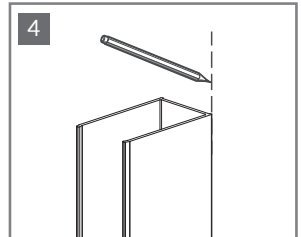
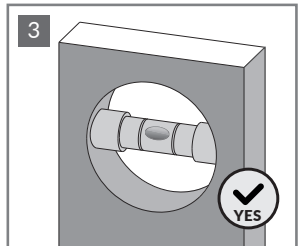
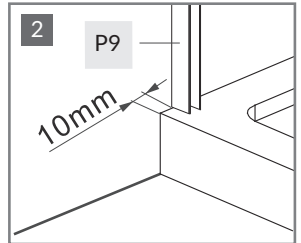
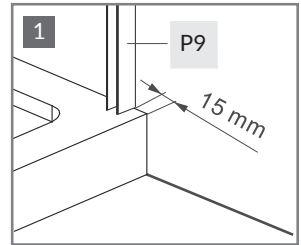

P9  x1



3.

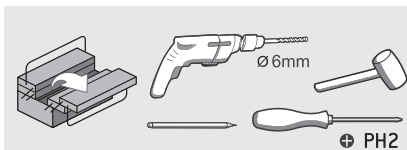
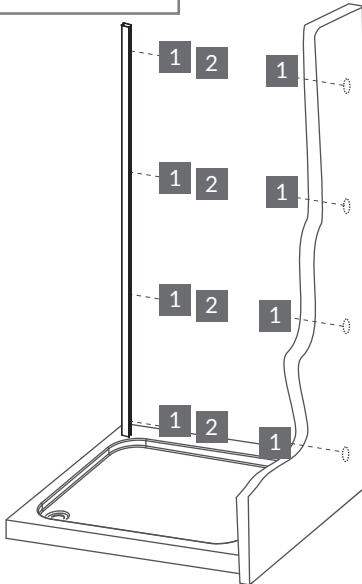
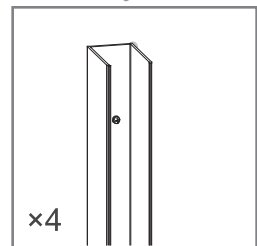
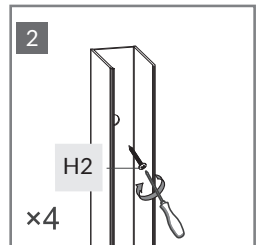
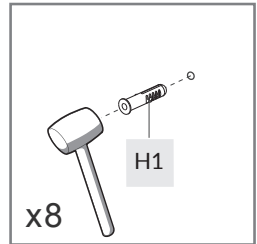
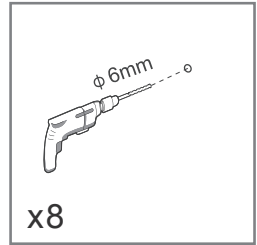
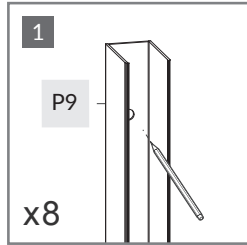
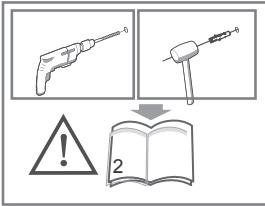

H1
H2
P9

 x8
 x4
 x1



4.

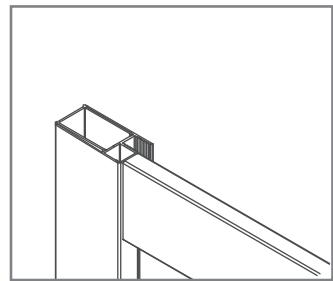
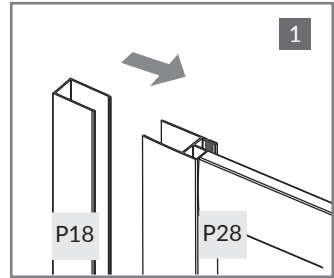
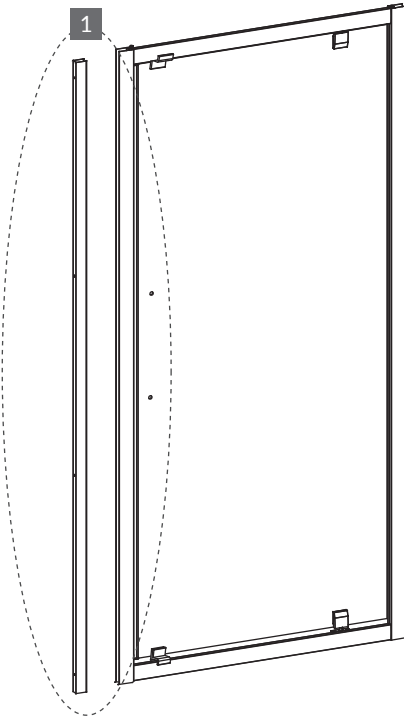
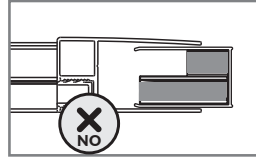
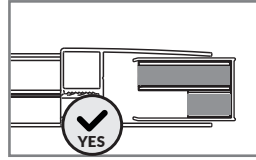

P28

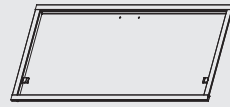

x1

P18



x1



5.

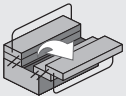
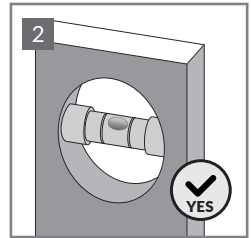
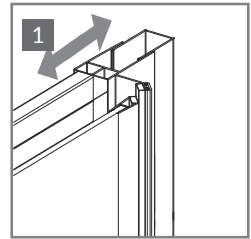
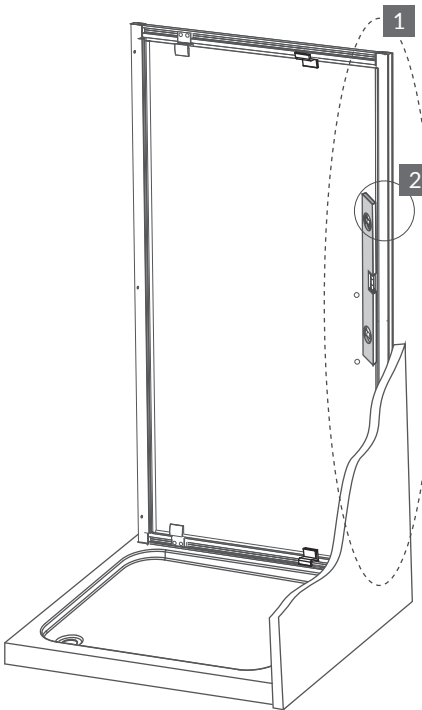
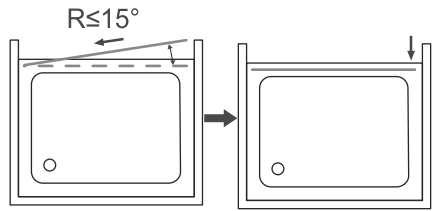
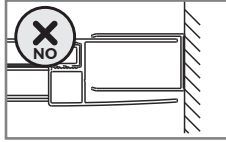
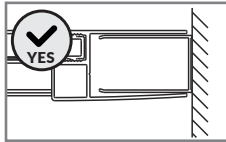
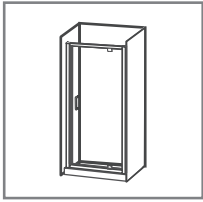

6.

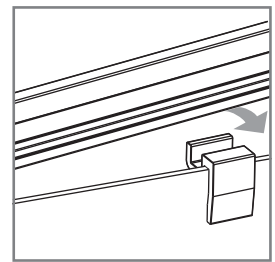
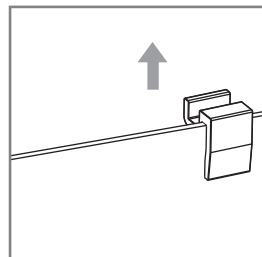
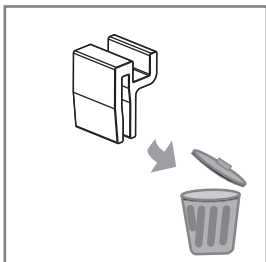
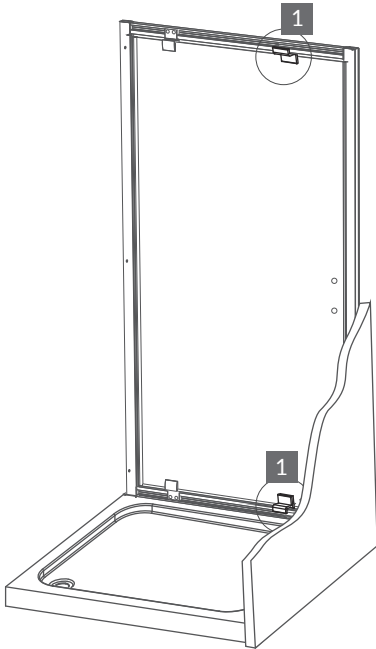
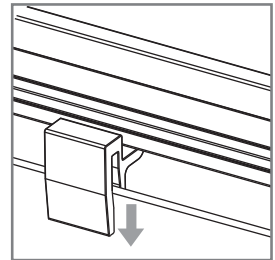
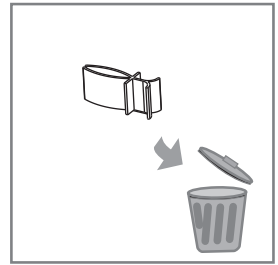
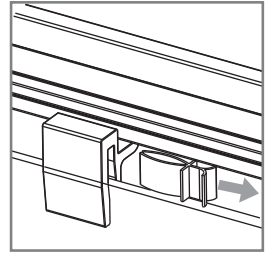
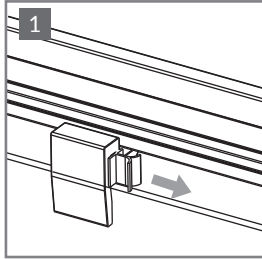
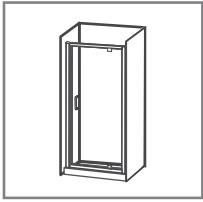

7.

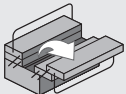
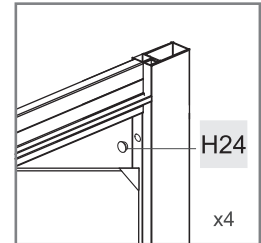
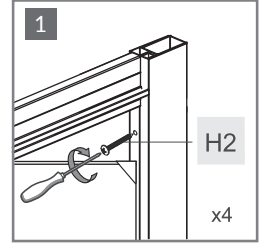
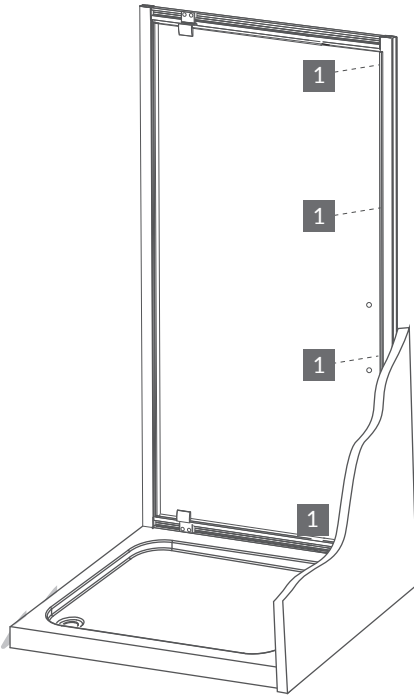

⊕ PH2

H2



x4

H24



x4



8.

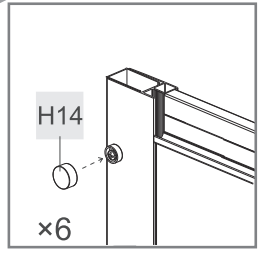
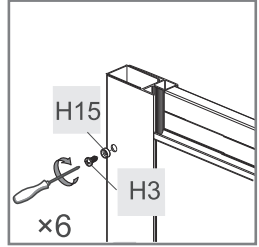
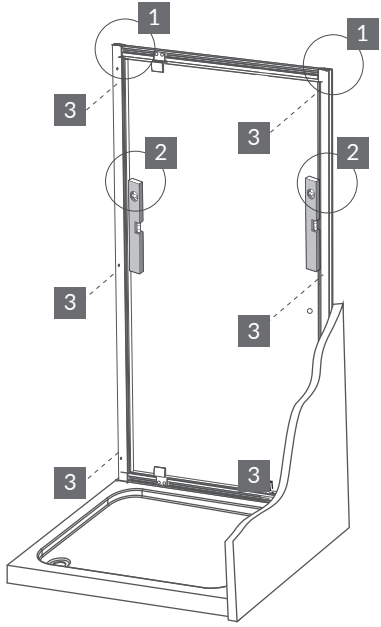
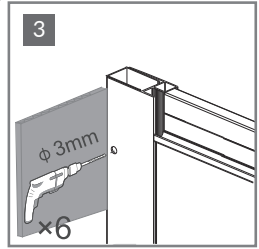
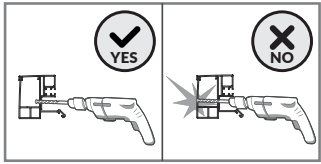
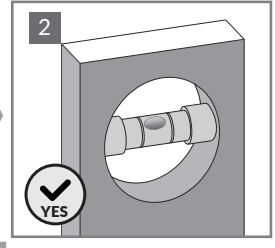
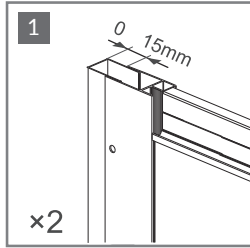

| | | | | | | |
|--|--|--|-----|--|----|--|
| | | | H3 | | x6 | |
| | | | H14 | | x6 | |
| | | | H15 | | x6 | |

9.

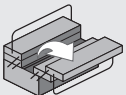
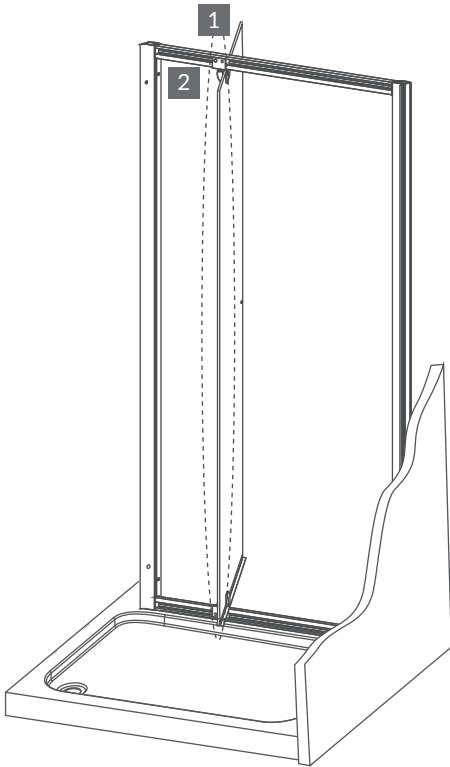
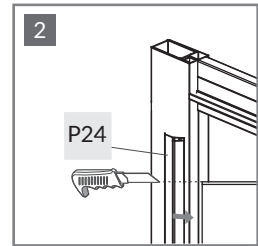
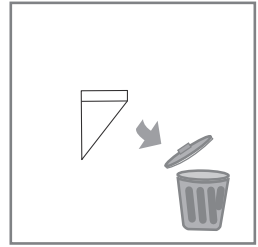
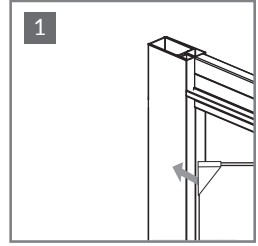

P24

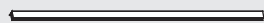

x1



10.

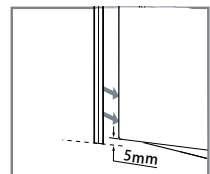
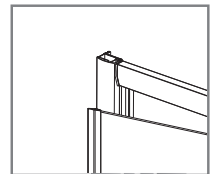
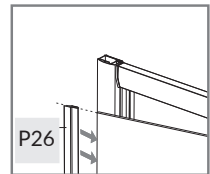
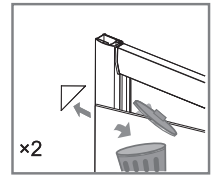
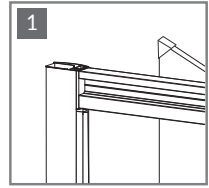
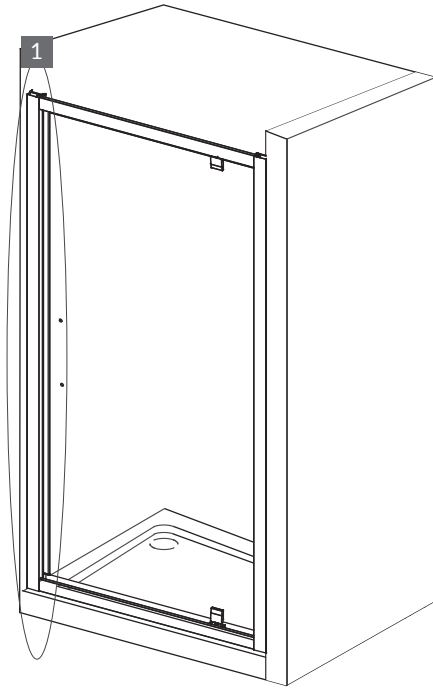

P26

x1



11.

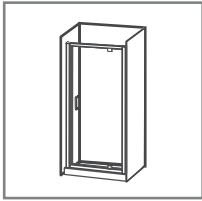

1

| SIZE | L |
|------------|--------|
| 700X1900mm | ≈421mm |
| 800X1900mm | ≈521mm |
| 900X1900mm | ≈571mm |

P23

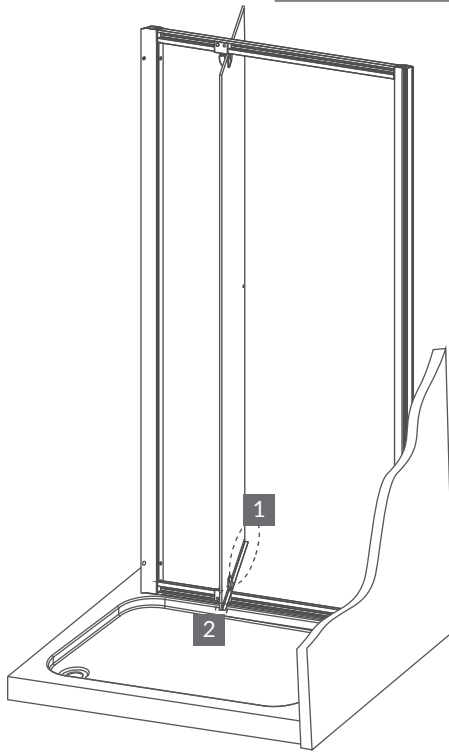
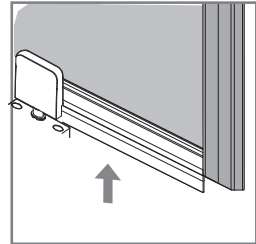

2

| SIZE | L 1 |
|------------|--------|
| 700X1900mm | ≈73mm |
| 800X1900mm | ≈73mm |
| 900X1900mm | ≈123mm |

P27

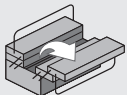
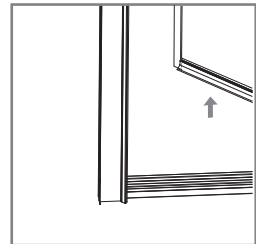

P23  x1

P27  x1



12.

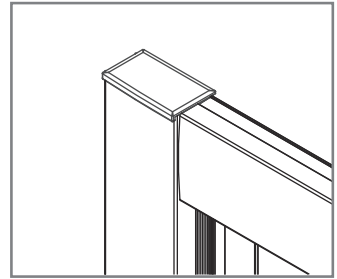
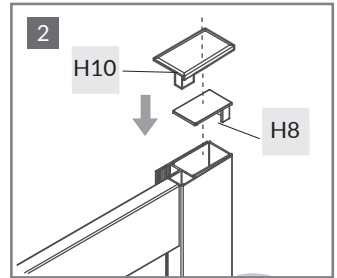
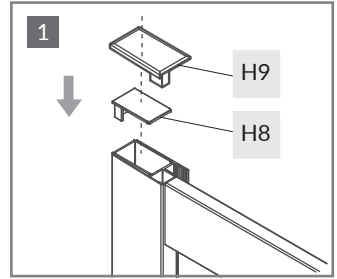
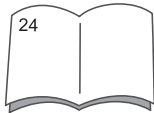
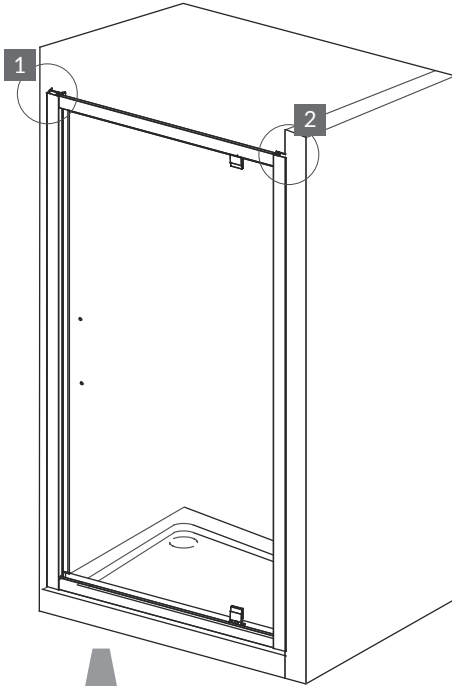

H8 x2



H9 x1



H10 x1



13.

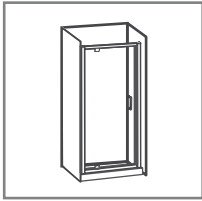

| SIZE | X(mm) |
|------------|---------|
| 700X1900mm | 670-700 |
| 800X1900mm | 770-800 |
| 900X1900mm | 870-900 |

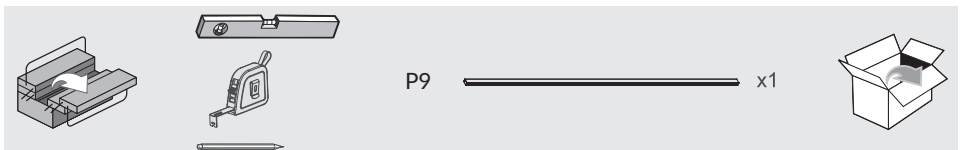
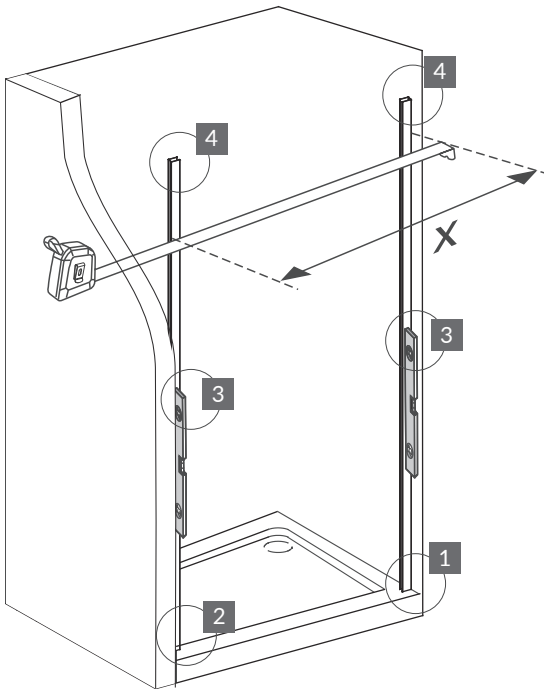
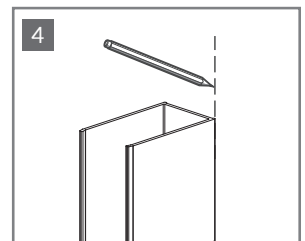
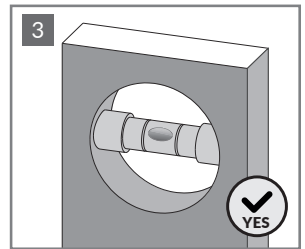
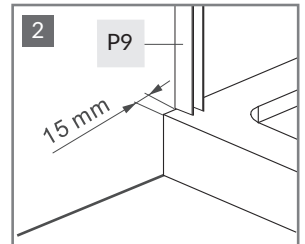
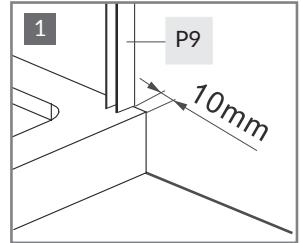

14.

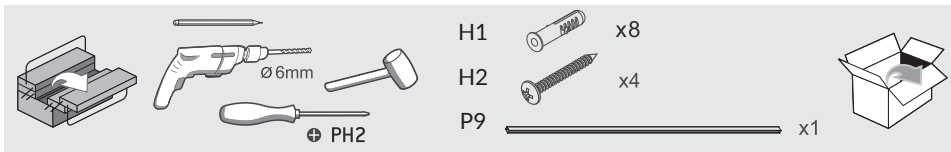
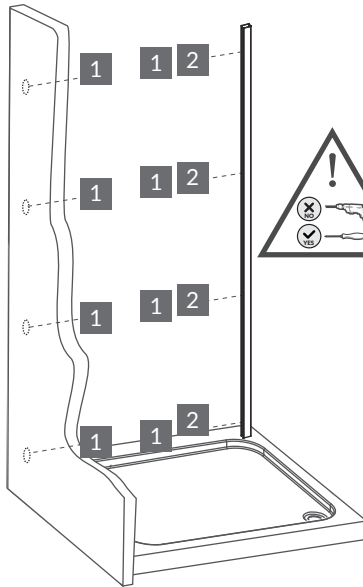
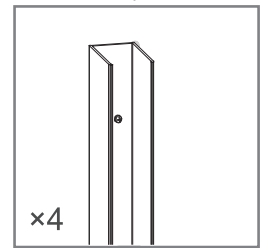
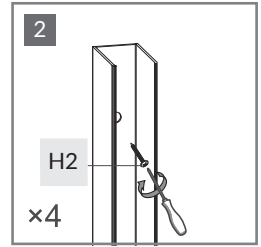
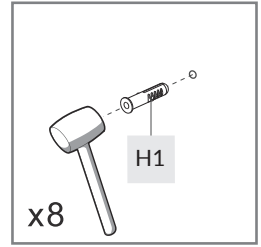
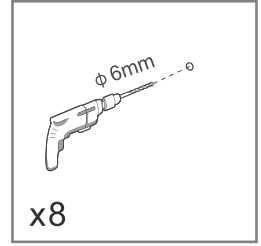
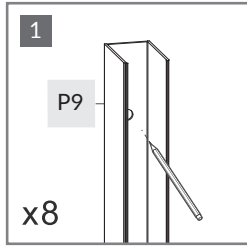
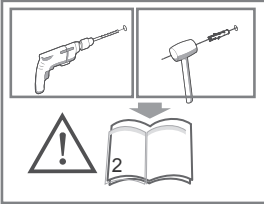

15.

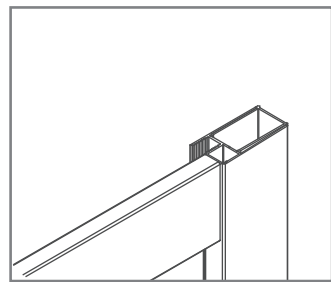
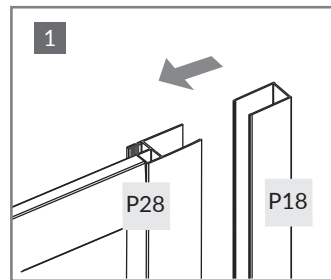
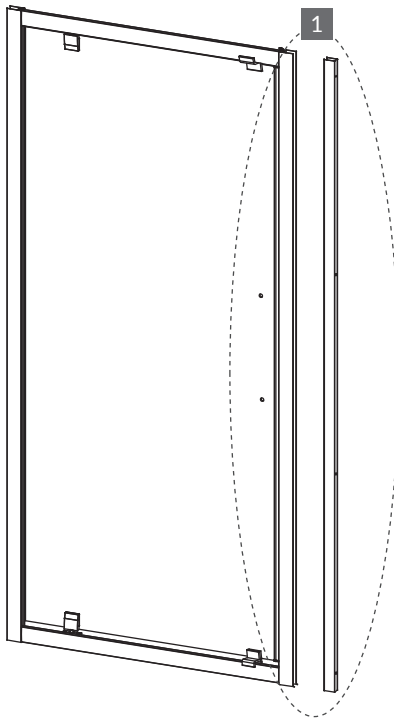
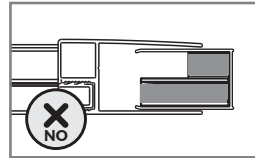
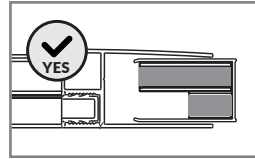

P28



x1

P18



x1



16.

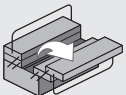
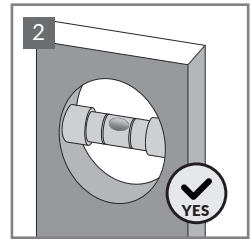
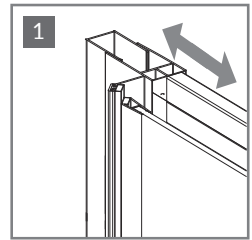
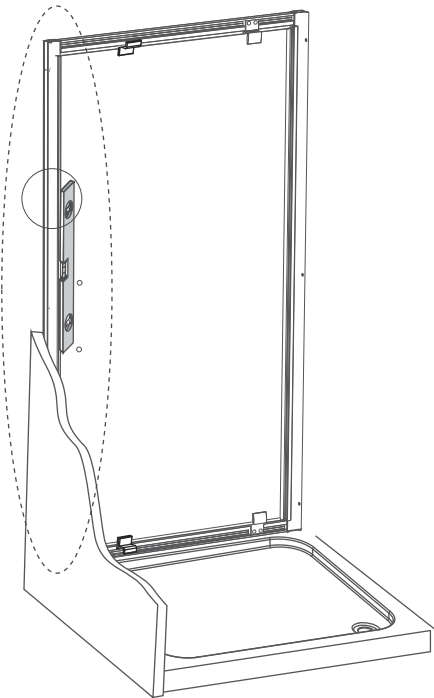
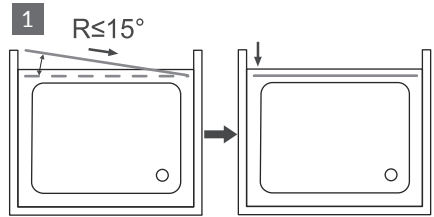
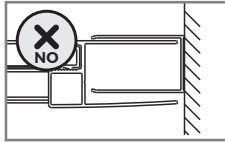
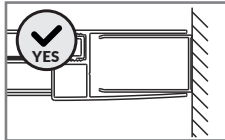
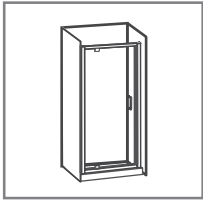

17.

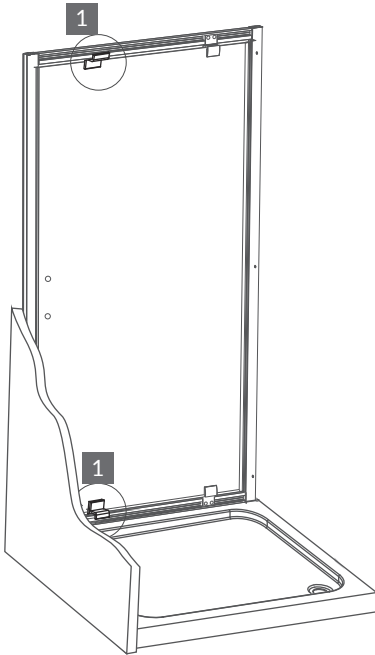
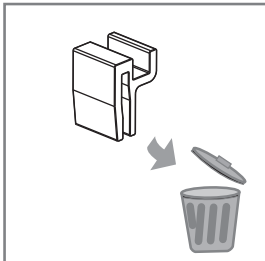
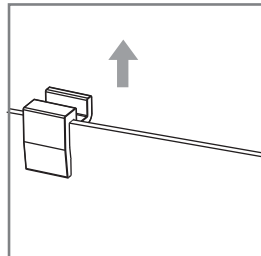
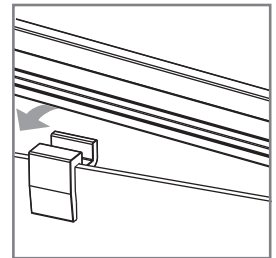
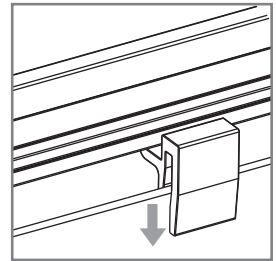
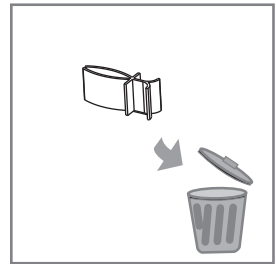
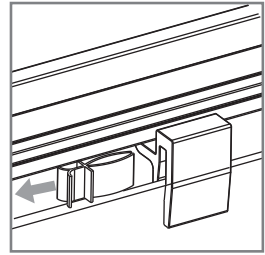
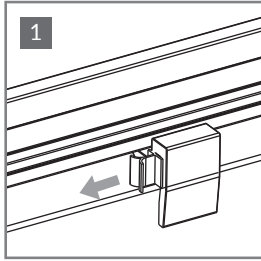
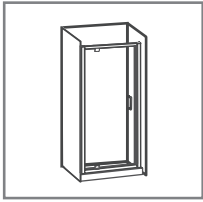

18.

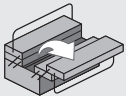
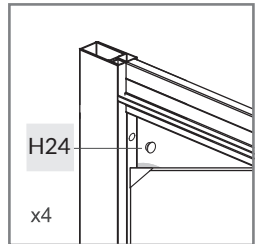
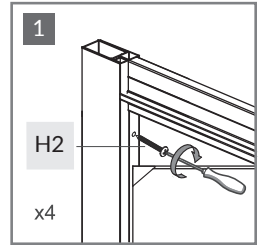
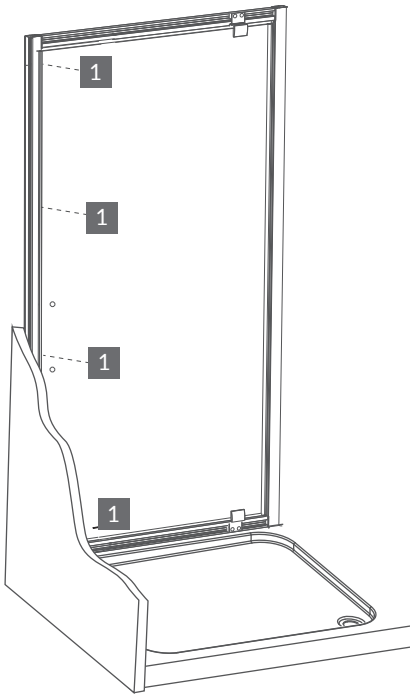

H2



x4

H24



x4



19.

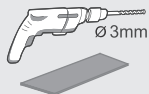
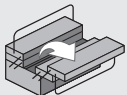
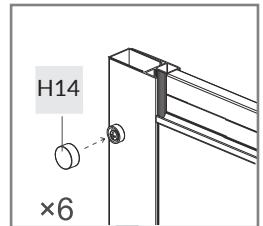
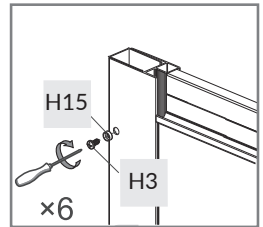
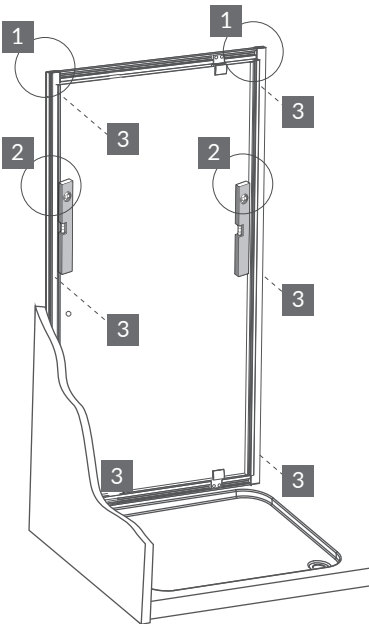
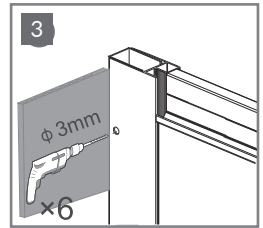
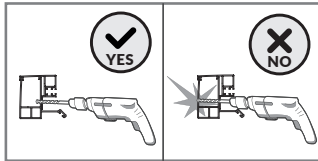
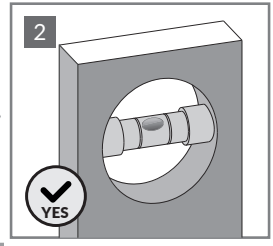
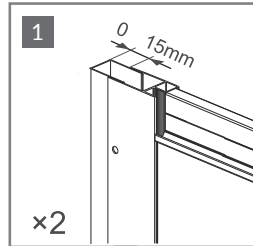
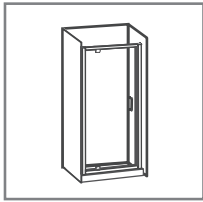

H3  x6

H14  x6

H15  x6



20.

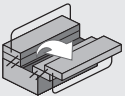
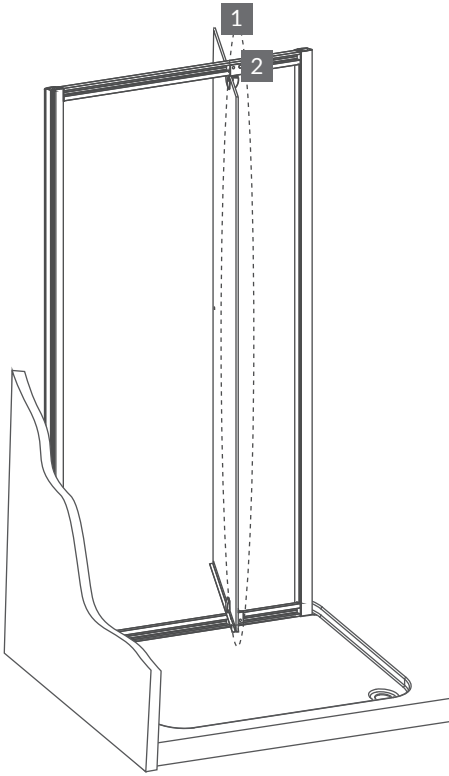
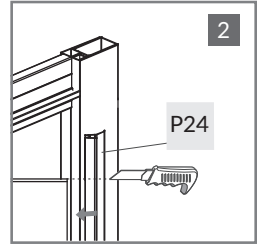
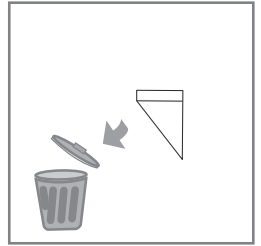
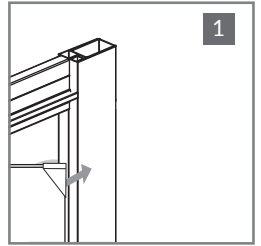

P24  x1



21.

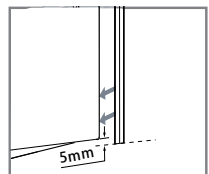
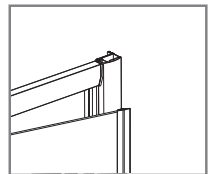
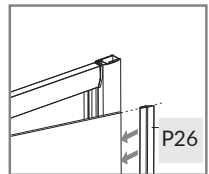
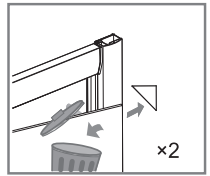
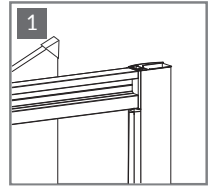
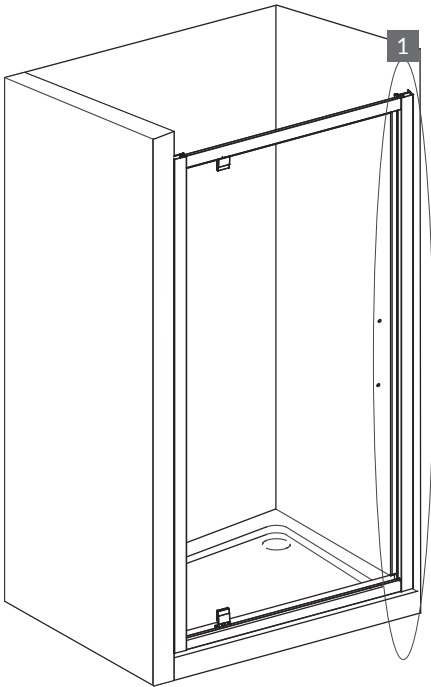

P26



x1



22.



1

| SIZE | L |
|------------|--------|
| 700X1900mm | ≈421mm |
| 800X1900mm | ≈521mm |
| 900X1900mm | ≈571mm |

P23

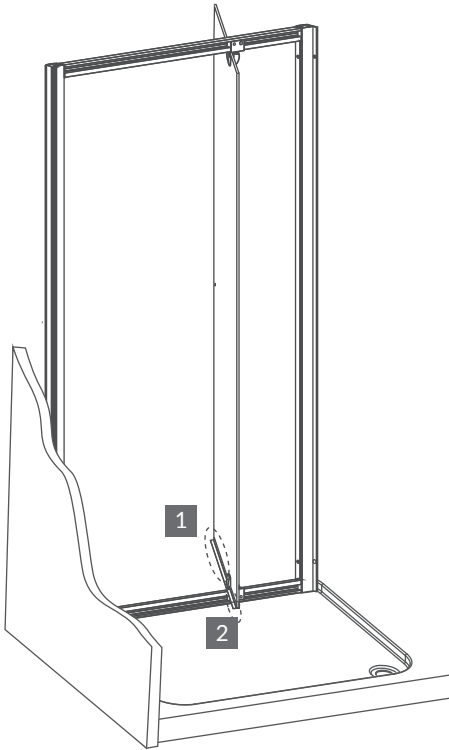
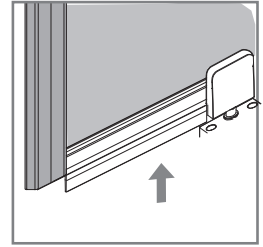

2

| SIZE | L1 |
|------------|--------|
| 700X1900mm | ≈73mm |
| 800X1900mm | ≈73mm |
| 900X1900mm | ≈123mm |

L1

P27

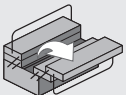
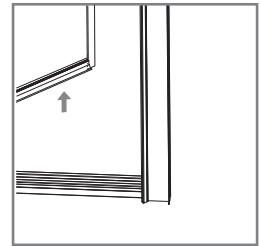

P23

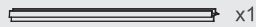

P27

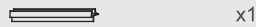

23.

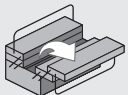
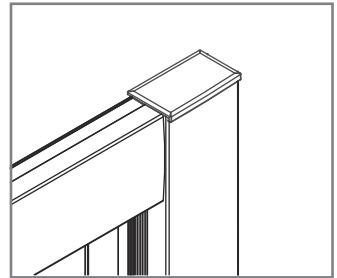
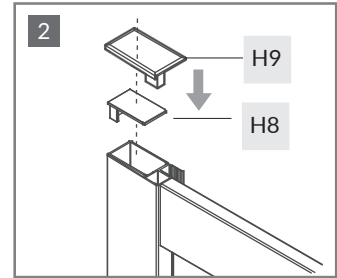
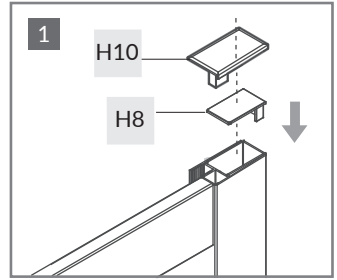
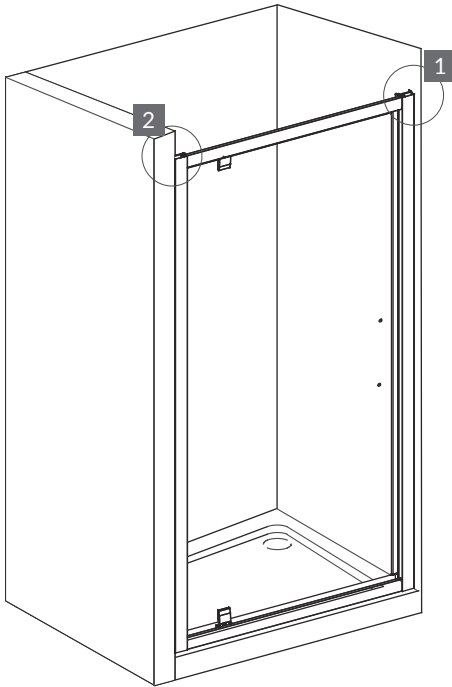

H8



x2

H9



x1

H10



x1



24.

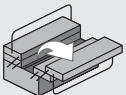
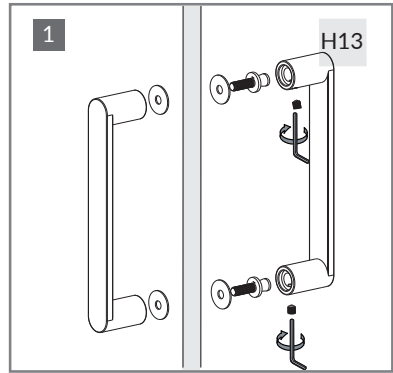
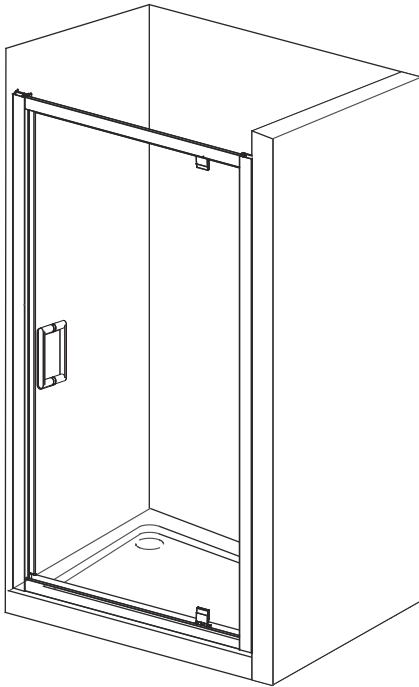

H13



x1



25.

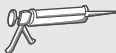
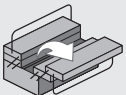
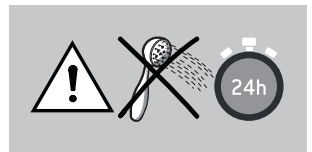
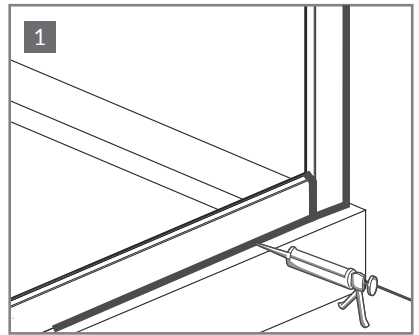
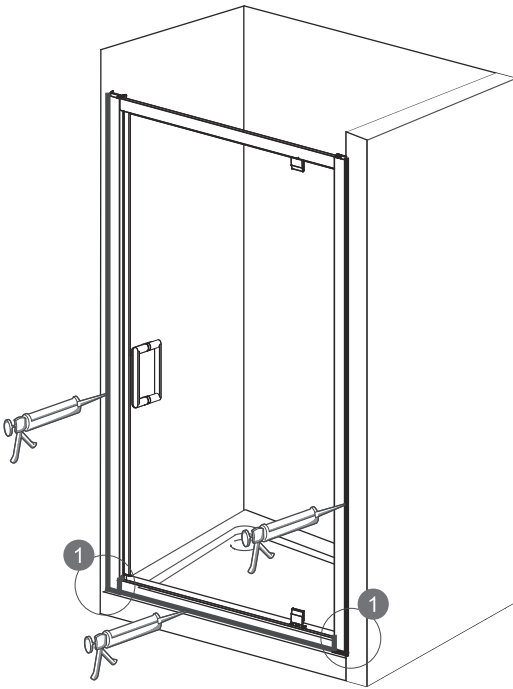



6.5 < PH < 7.5

