

# CREA

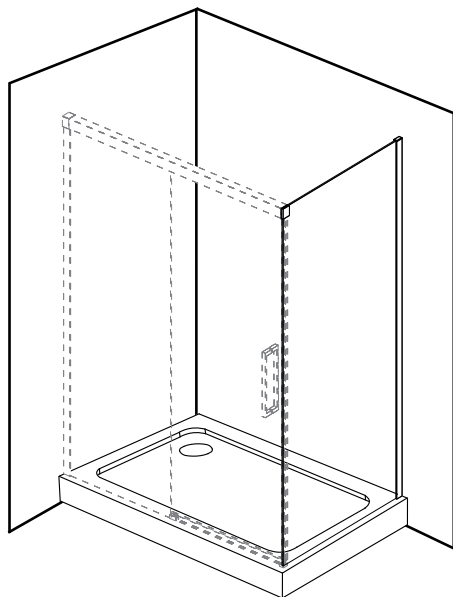

PL INSTRUKCJA MONTAŻU I EKSPLOATACJI

CZ NÁVOD NA MONTÁŽ A ÚDRŽBU

SK NÁVOD NA MONTÁŽ A ÚDRŽBU

EST PAIGALDUS- JA KASUTUSJUHEND

LT MONTAVIMO IR EKSPLOATAVIMO INSTRUKCIJA

LV MONTĀŽAS UN EKSPLUATĀCIJAS INSTRUKCIJA

DE MONTAGE- UND AUFBAUANLEITUNG

RO INSTRUCȚIUNI DE MONTAJ ȘI OPERARE

HU SZERELÉSI ÉS ÜZEMELTETÉSI ÚTMUTATÓ

UA ІНСТРУКЦІЯ З МОНТАЖУ І ЕКСПЛУАТАЦІЇ

BY ІНСТРУКЦЫЯ ПА МАНТАЖЫ І ЭКСПЛУАТАЦЫІ

RU ИНСТРУКЦИЯ ПО МОНТАЖУ И ЭКСПЛУАТАЦИИ

EN INSTRUCTIONS FOR ASSEMBLY AND USE



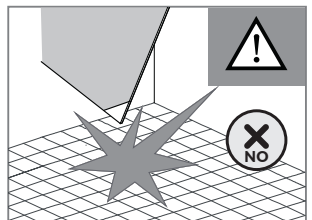
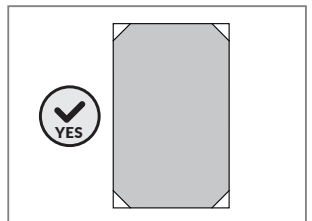
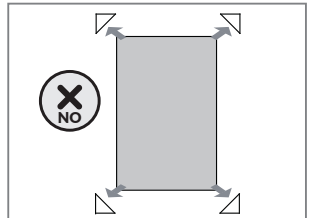
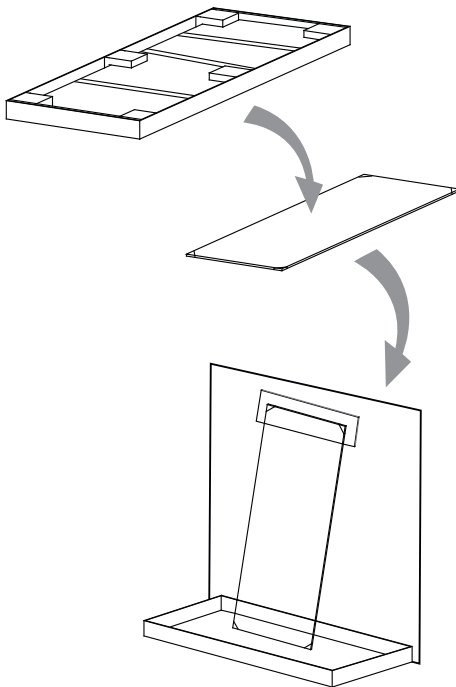
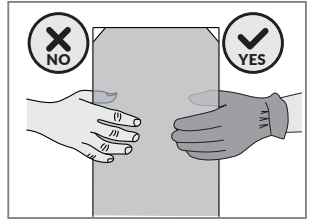
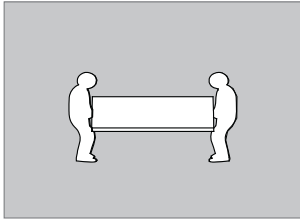
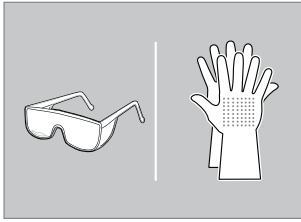
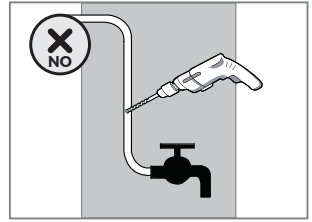
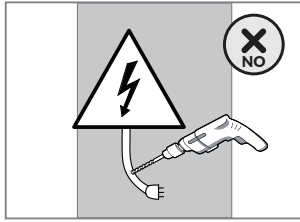
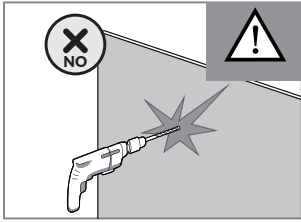

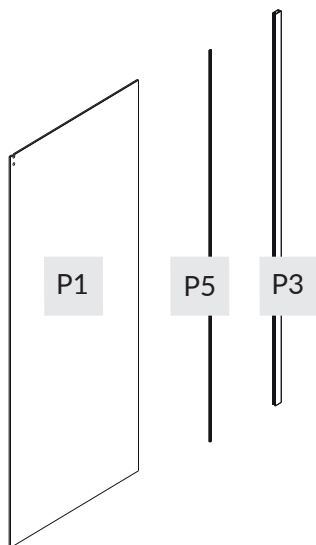

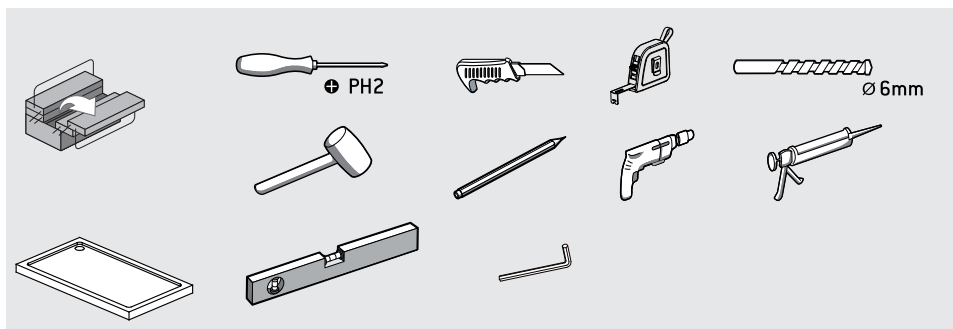
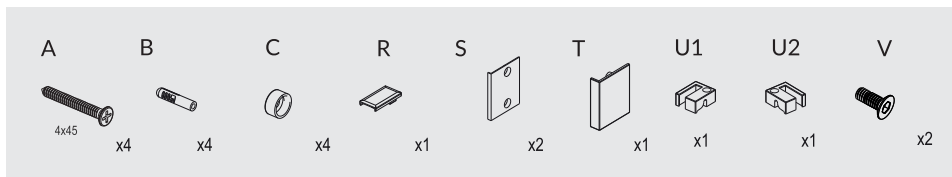

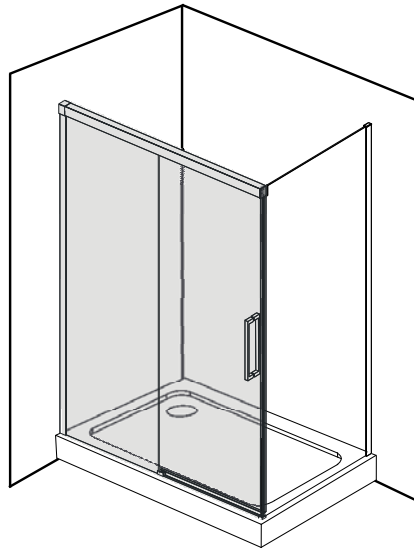
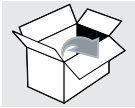















FR INSTALLATION ET UTILISATION – MODE









- |   |  |  |  |   |  |   |
|---|--|--|--|---|--|---|
| <b>A</b><br><br>4x45<br>x8 | <b>B</b><br><br>x8    | <b>C</b><br><br>x4              | <b>D</b><br><br>x1    | <b>E</b><br><br>x1           | <b>F</b><br><br>x1            |   |
| <b>G</b><br><br>x1       | <b>H</b><br><br>x1  | <b>I</b><br><br>x1            | <b>J</b><br><br>x1  | <b>K</b><br><br>x1         | <b>L</b><br><br>x1          |   |
| <b>M1</b><br><br>x1      | <b>M2</b><br><br>x1 | <b>P</b><br><br>3.5x 12<br>x4 | <b>N</b><br><br>x1  | <b>F1</b><br><br>1mm<br>x4 | <b>F2</b><br><br>2mm<br>x4  | <b>F3</b><br><br>3mm<br>x4 |
| <b>L1</b><br><br>x1      | <b>L2</b><br><br>x1 | <b>Q1</b><br><br>x1           | <b>Q2</b><br><br>x1 | <b>R</b><br><br>x1         | <b>S</b><br><br>Ø PH2<br>x1 |   |

1.

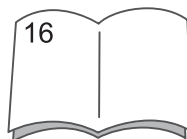
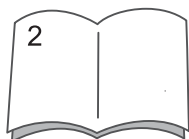
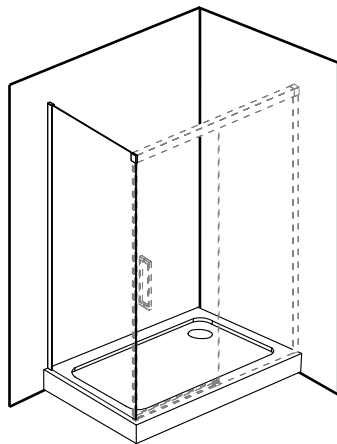
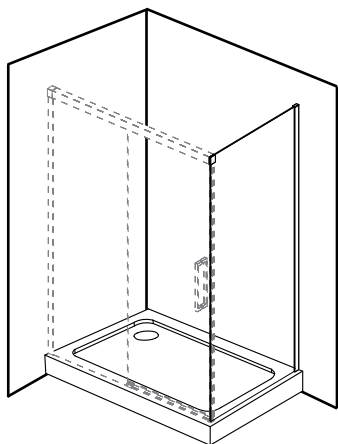

## 2.

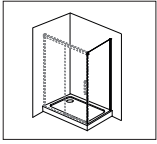

SIZE	X(mm)	Y(mm)
1200X800X2000	780-800	1180-1200
1200X900X2000	880-900	1180-1200
1400X800X2000	780-800	1380-1400
1400X900X2000	880-900	1380-1400

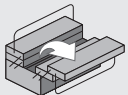
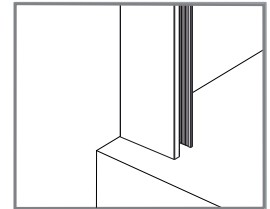
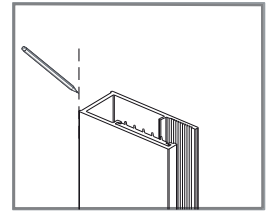
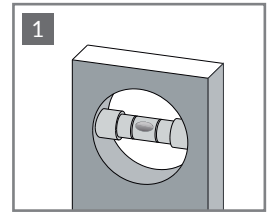
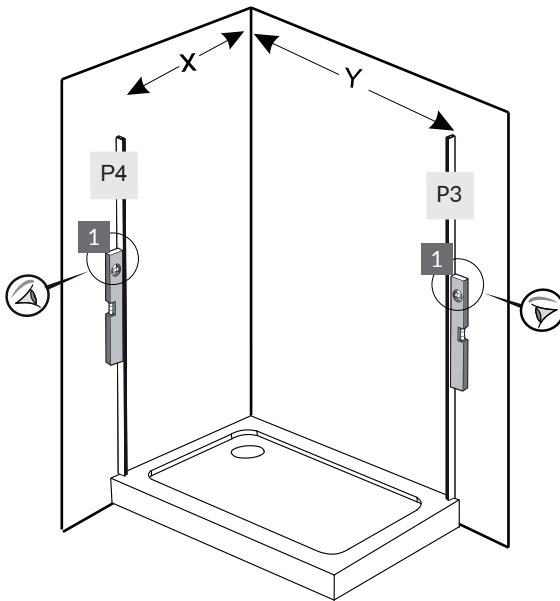

P4  x1

P3  x1



3.

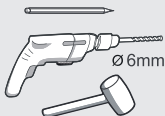
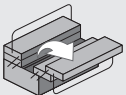
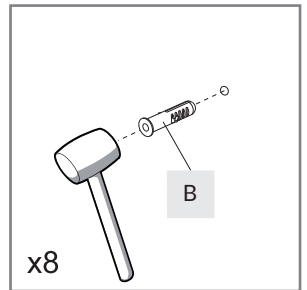
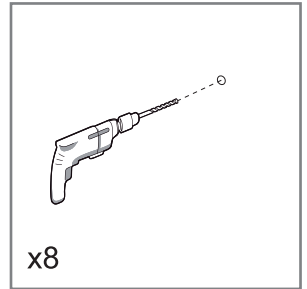
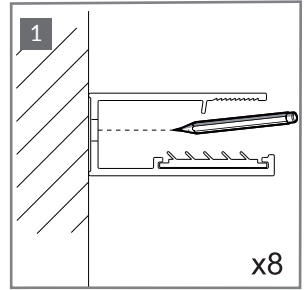
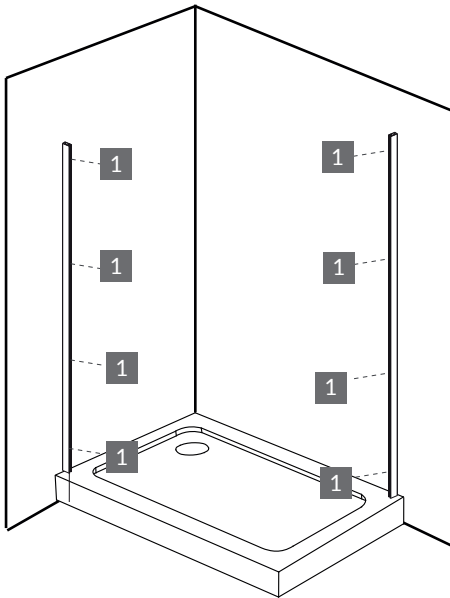
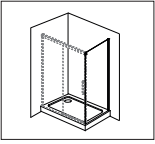

B





x8



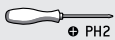
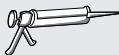
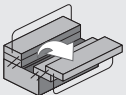
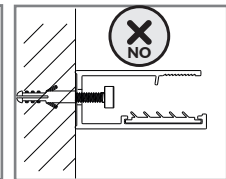
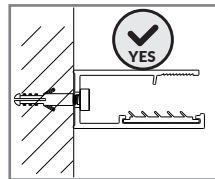
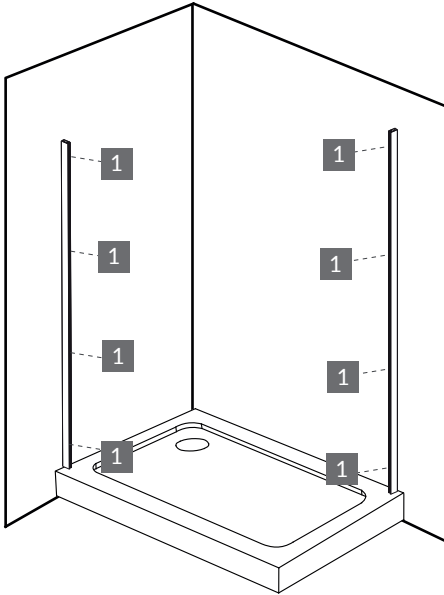
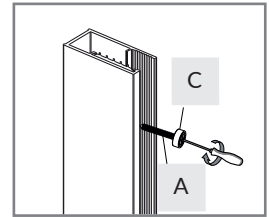
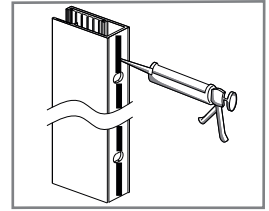
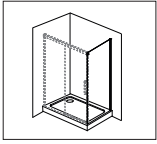

4.



P4  x1

P3  x1

C  x8

A  x8  
4x45



# 5.

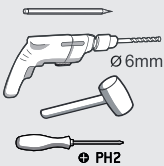
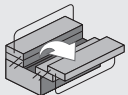
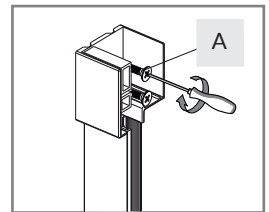
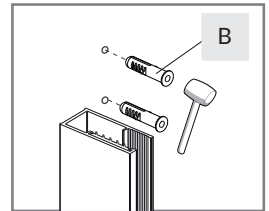
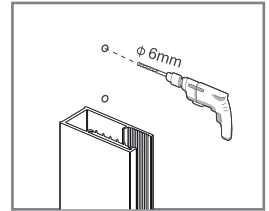
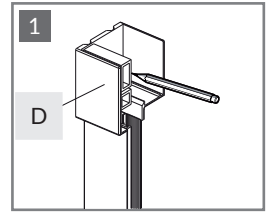
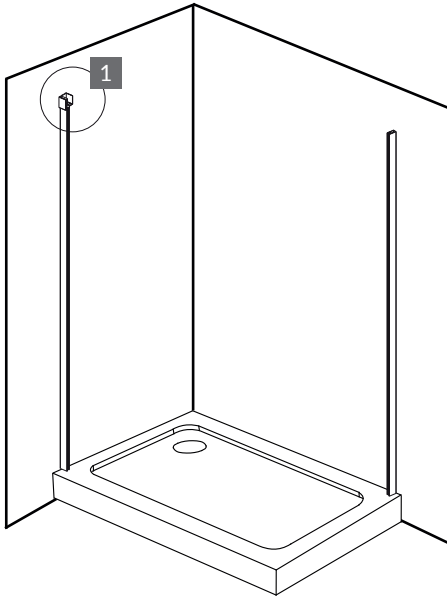
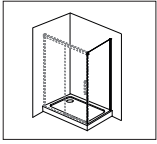

D



x1

B



x2

A



x2



6.

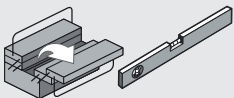
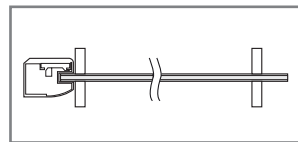
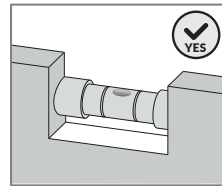
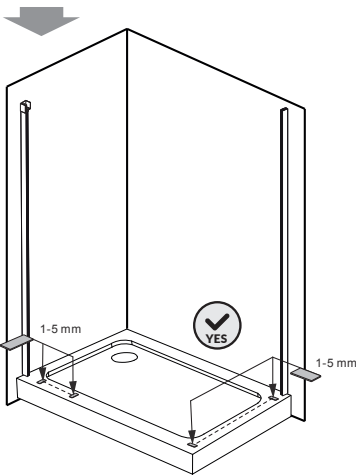
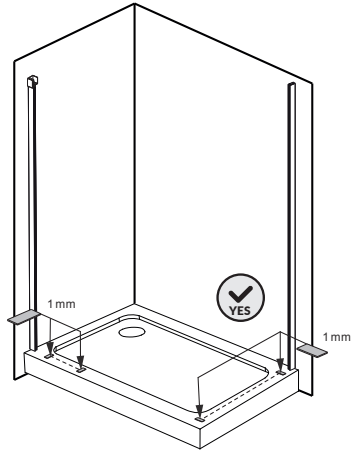
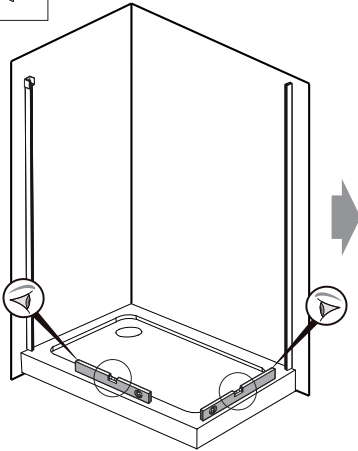
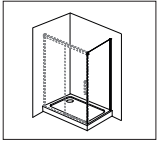

F1

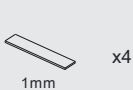

x4

F2

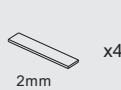

x4

F3



x4



# 7.

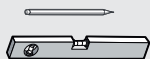
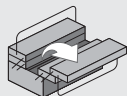
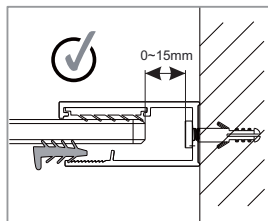
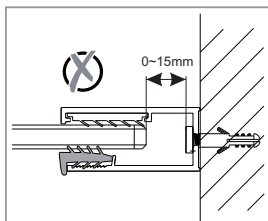
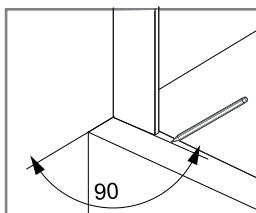
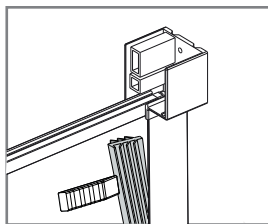
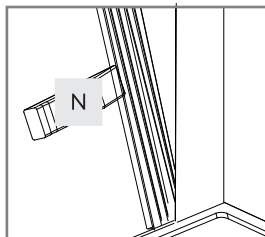
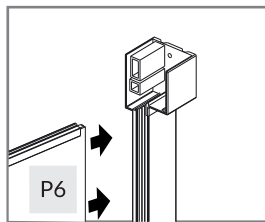
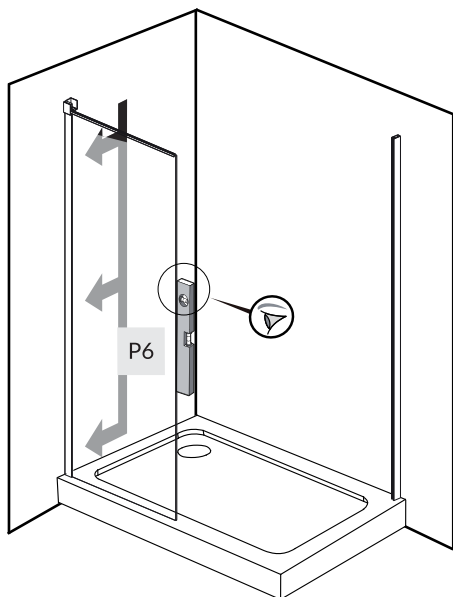
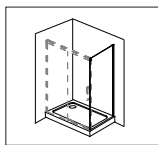

P5 ————— x1

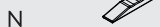

x1

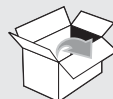

8.

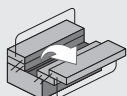
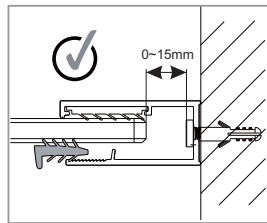
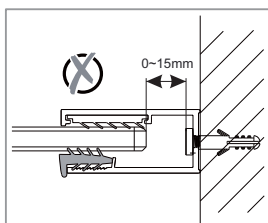
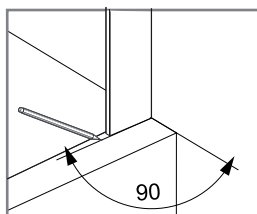
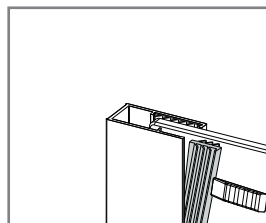
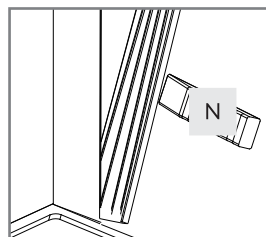
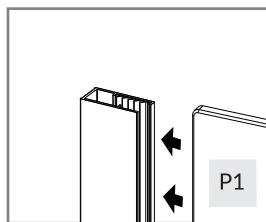
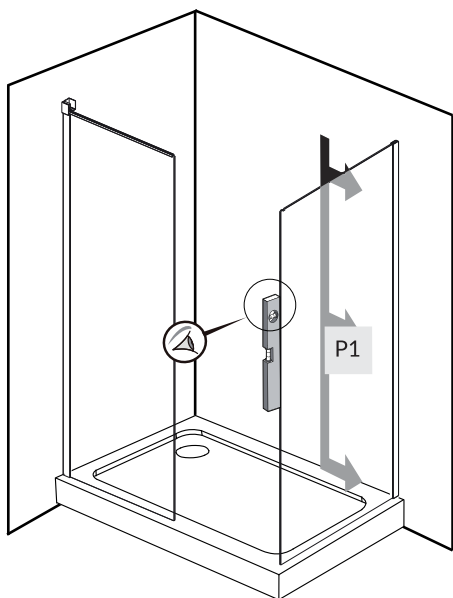
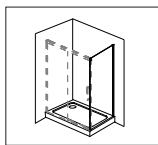

P5



x1

N



x1



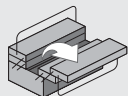
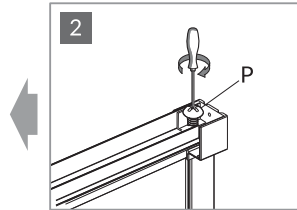
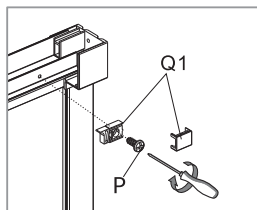
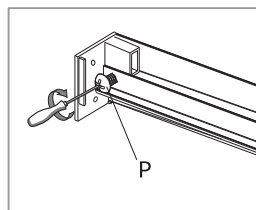
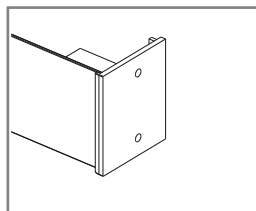
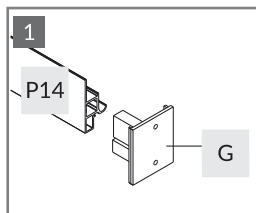
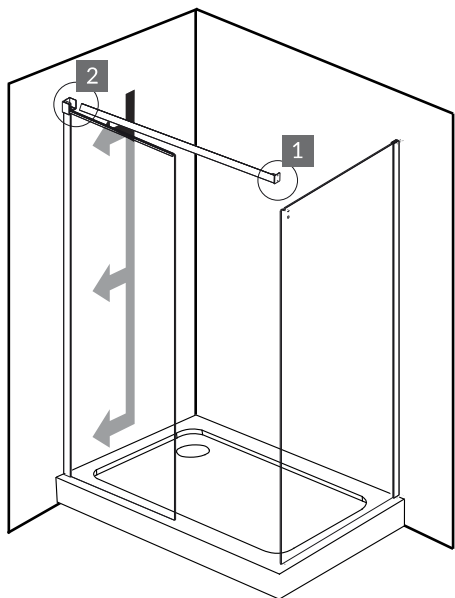
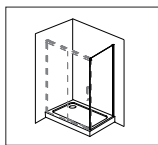

# 9.

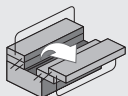
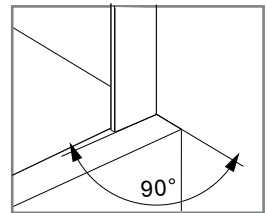
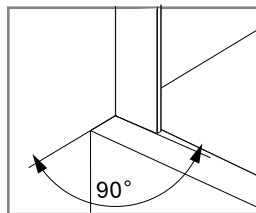
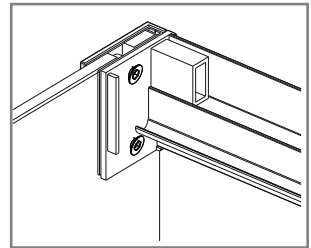
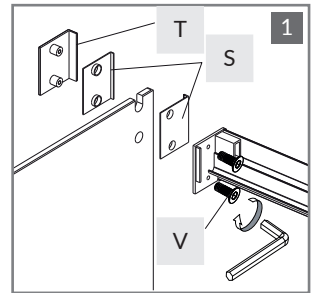
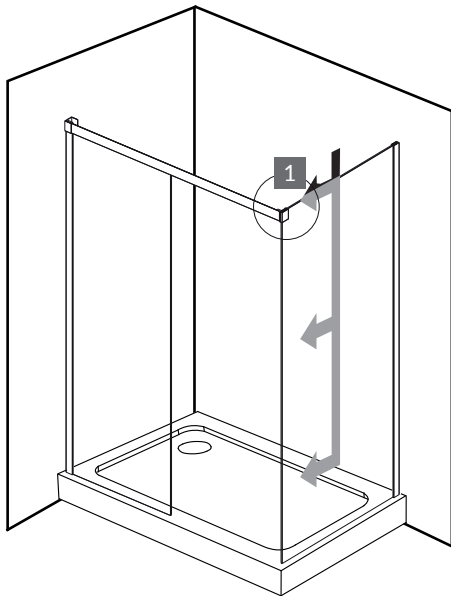
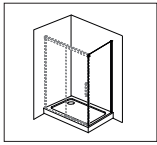

# 10.



- S  x2
- T  x1
- V  x2



# 11.

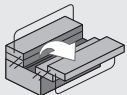
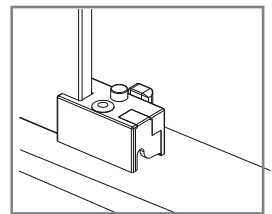
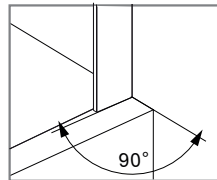
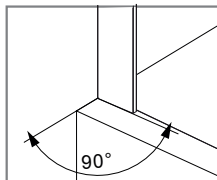
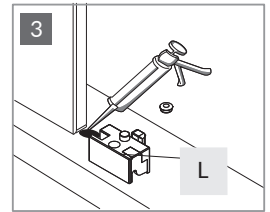
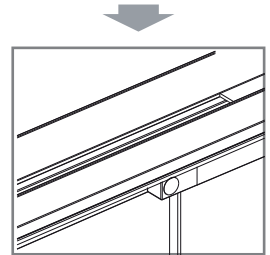
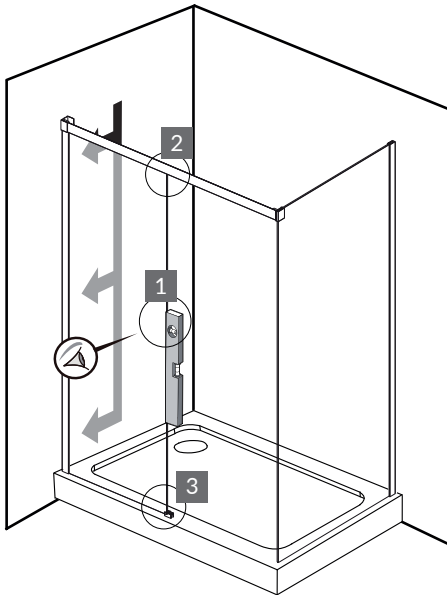
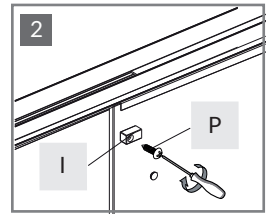
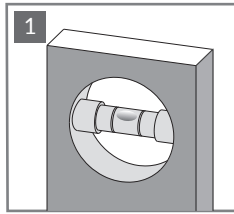
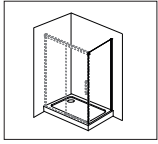

L



x1

I



x1

P



x1





# 12.

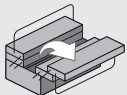
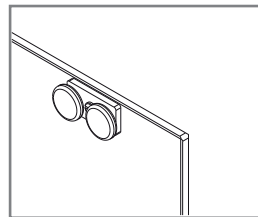
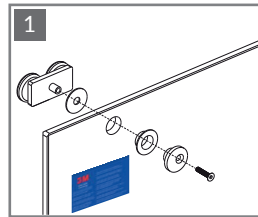
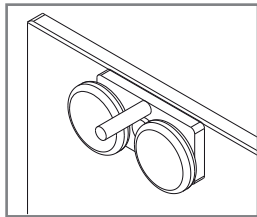
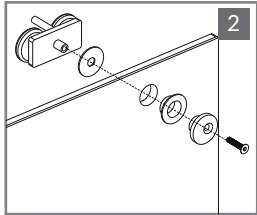
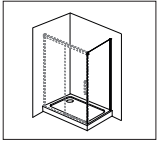





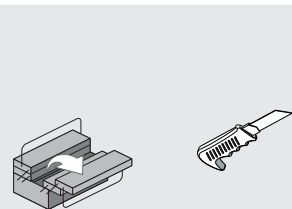
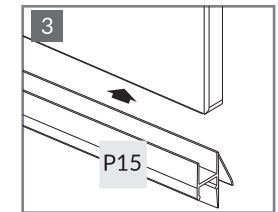
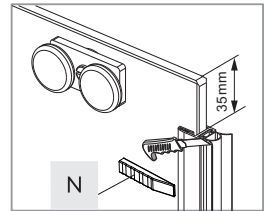
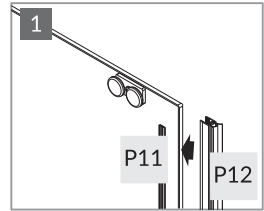
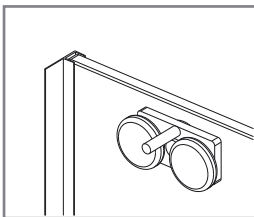
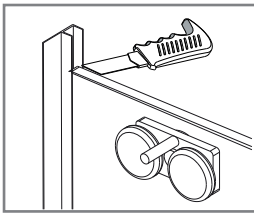
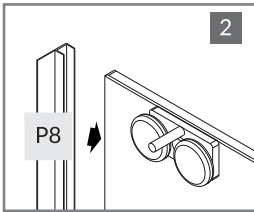
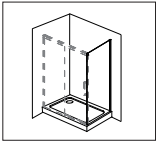

J  x1

K  x1



# 13.



- P12  x1
- P11  x1
- P8  x1
- P15  x1
- N  x1



14.

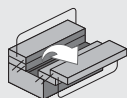
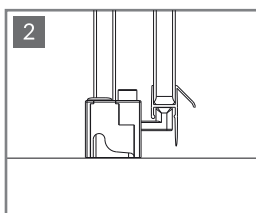
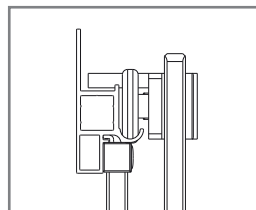
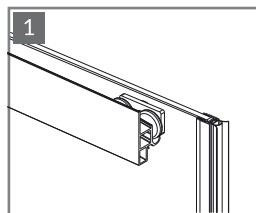
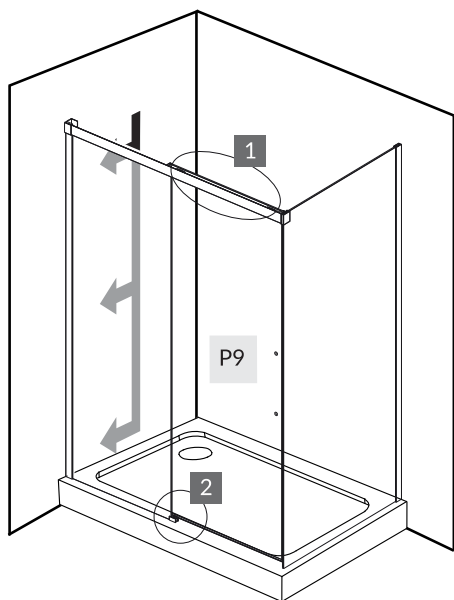
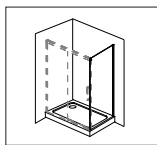

15.

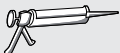
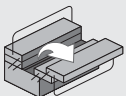
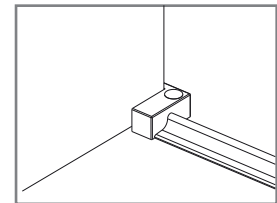
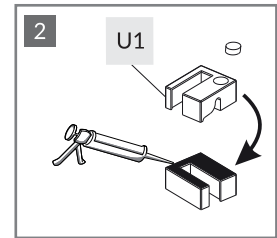
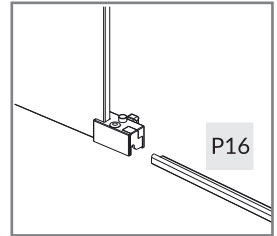
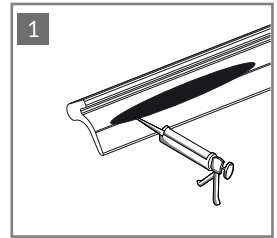
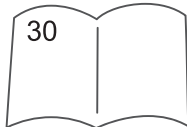
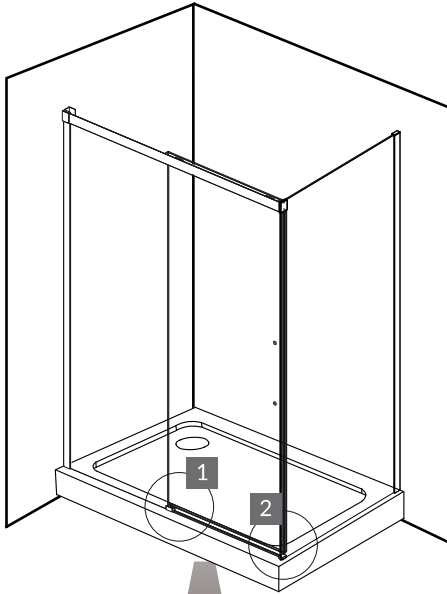
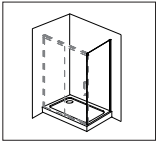

P16 — x1

U1 — x1



# 16.

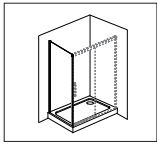

SIZE	X(mm)	Y(mm)
1200X800X2000	780-800	1180-1200
1200X900X2000	880-900	1180-1200
1400X800X2000	780-800	1380-1400
1400X900X2000	880-900	1380-1400

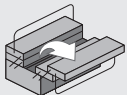
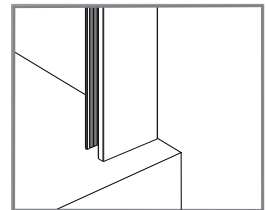
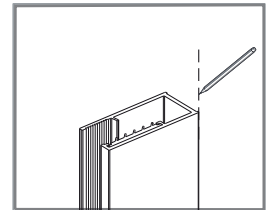
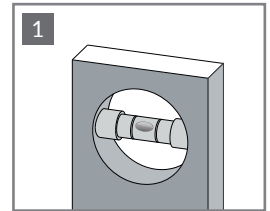
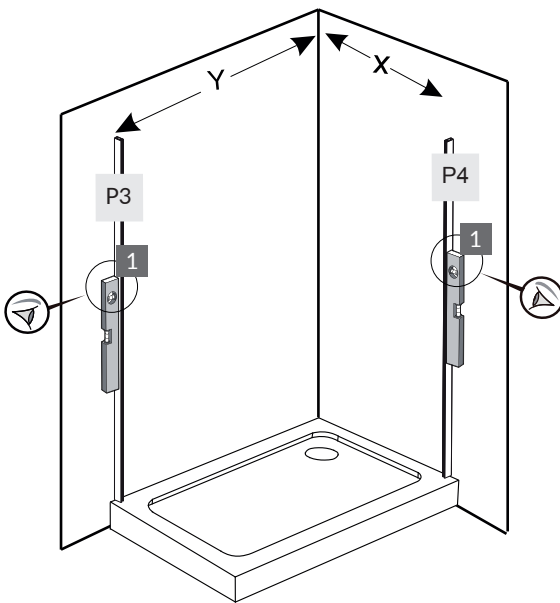

P4  x1

P3  x1



17.

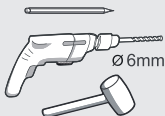
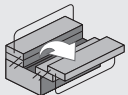
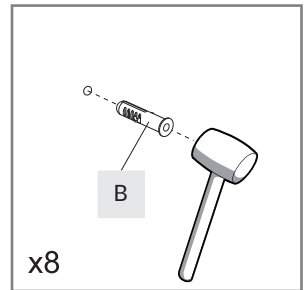
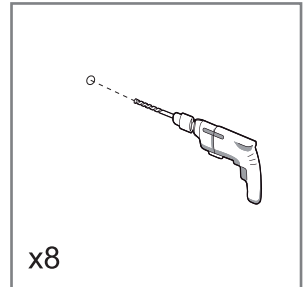
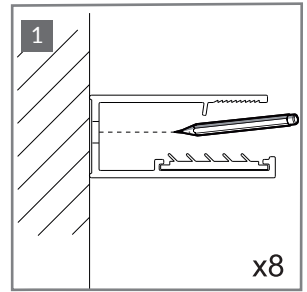
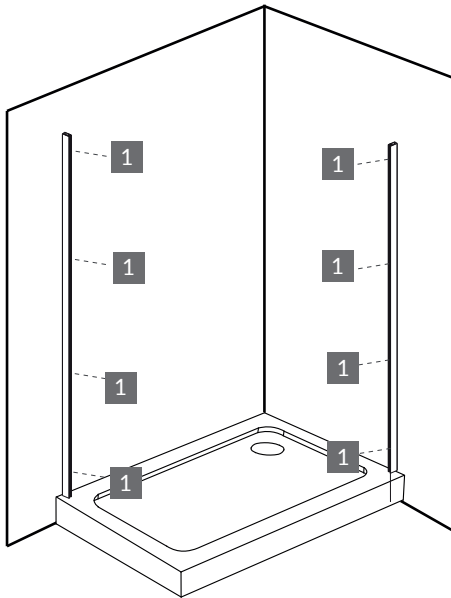
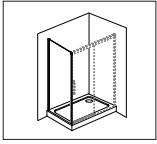

B



x8



18.

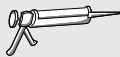
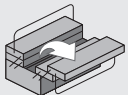
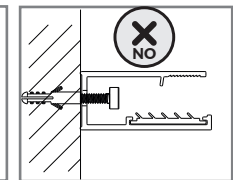
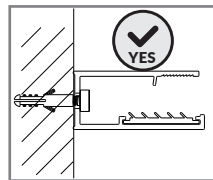
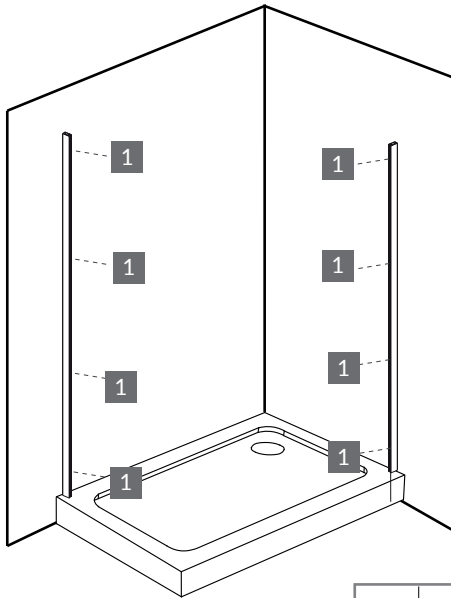
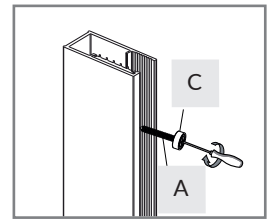
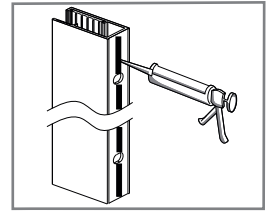
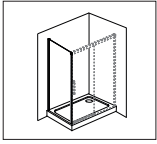

P4



x1

P3



x1

C



x8

A



x8



# 19.

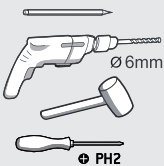
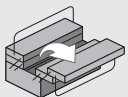
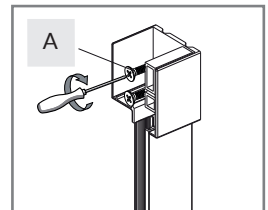
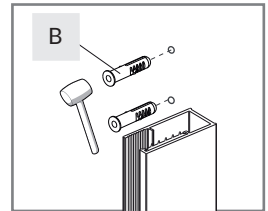
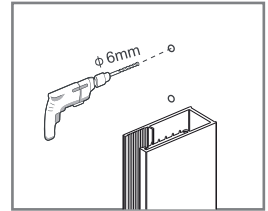
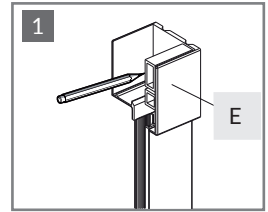
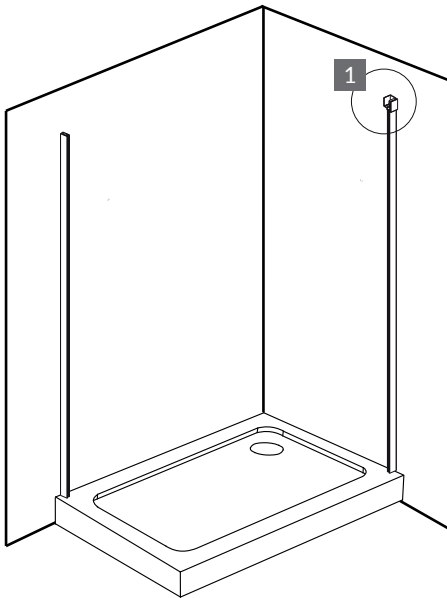
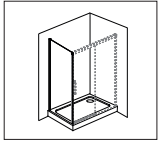

E  
B  
A



x1



x2



x2





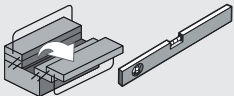
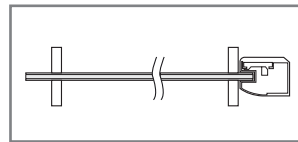
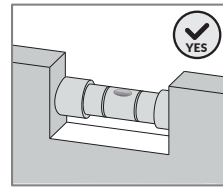
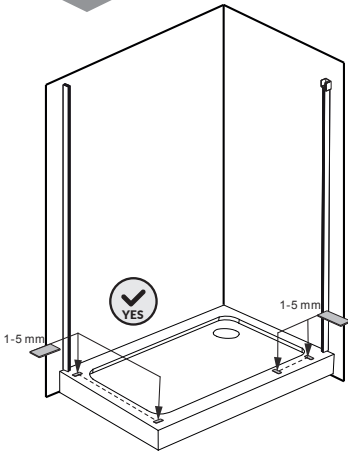
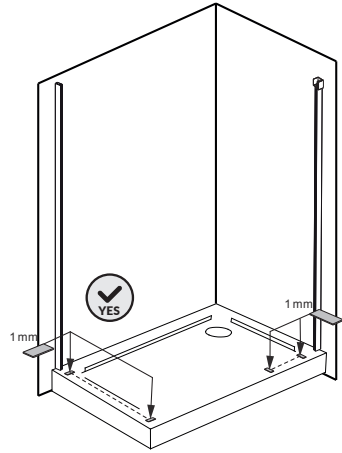
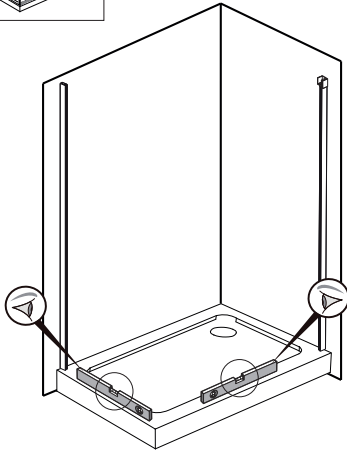
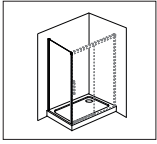

F1

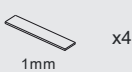

x4

F2



x4

F3



x4



21.

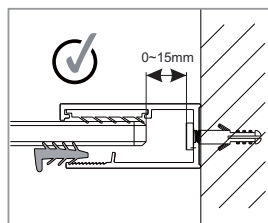
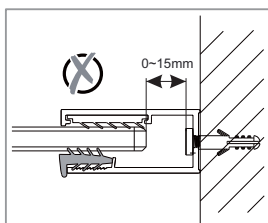
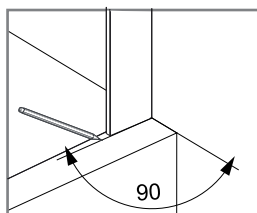
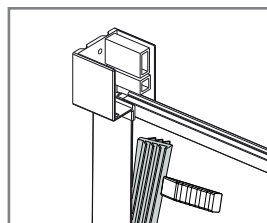
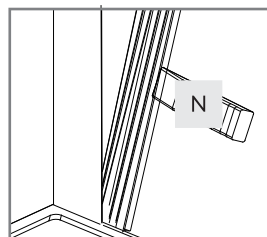
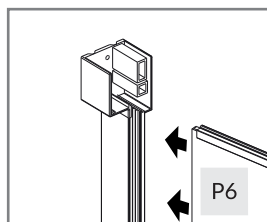
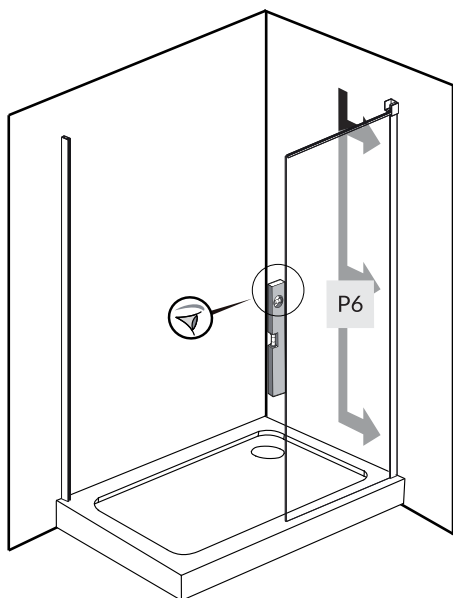
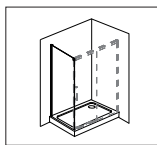

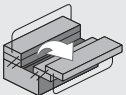
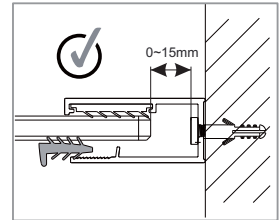
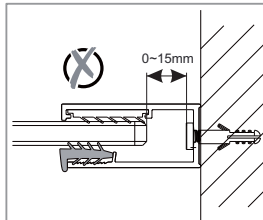
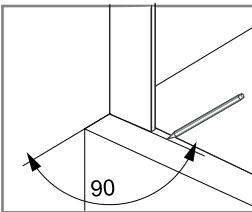
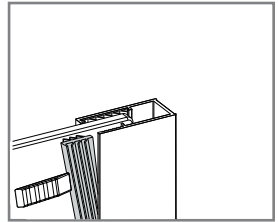
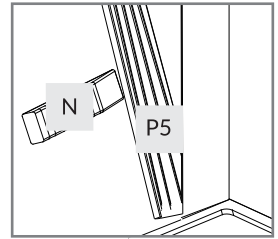
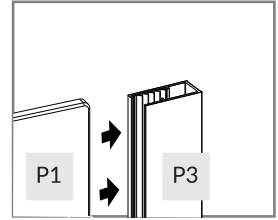
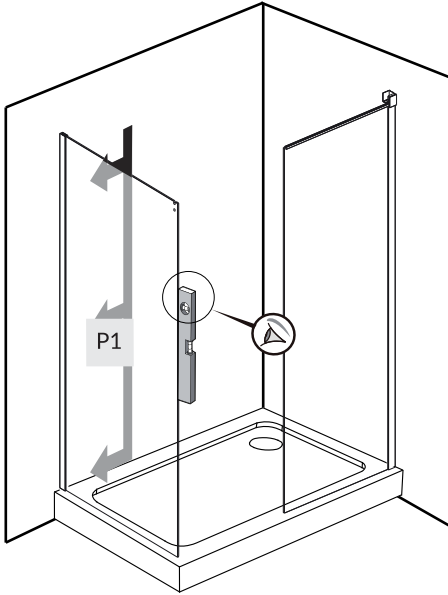
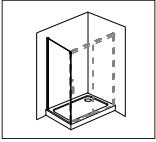

P5



x1

N



x1



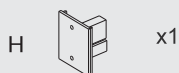
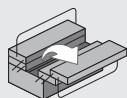
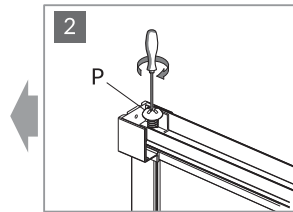
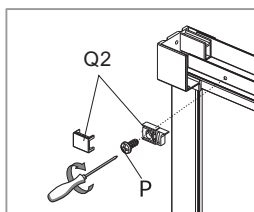
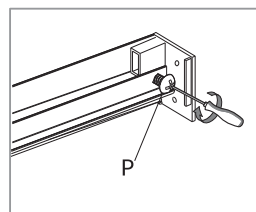
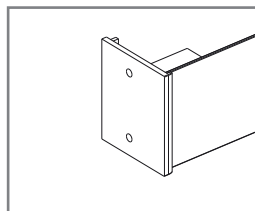
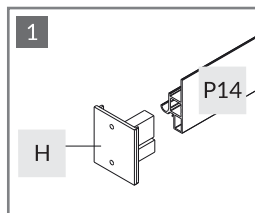
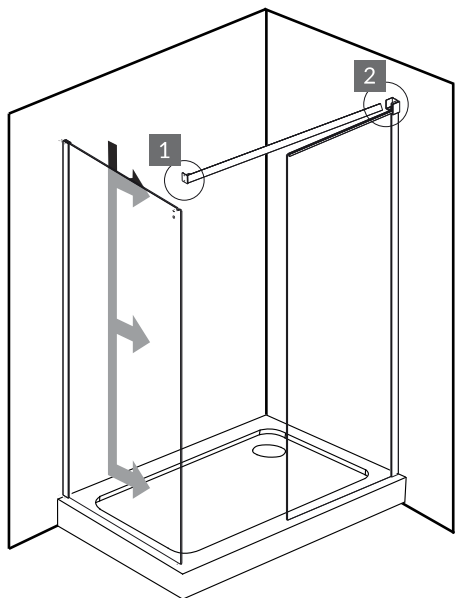
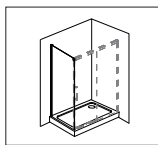

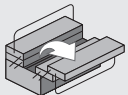
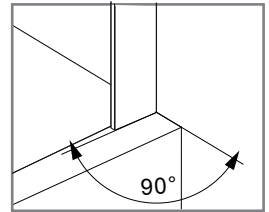
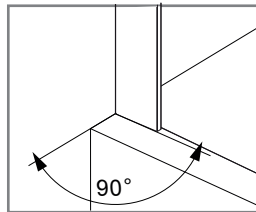
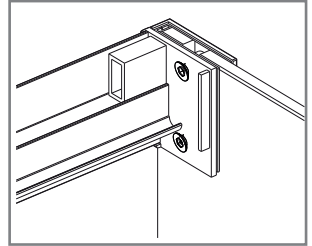
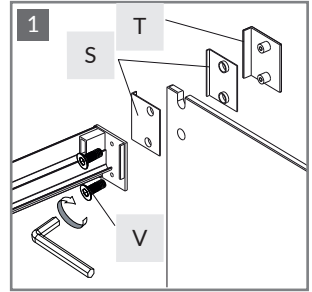
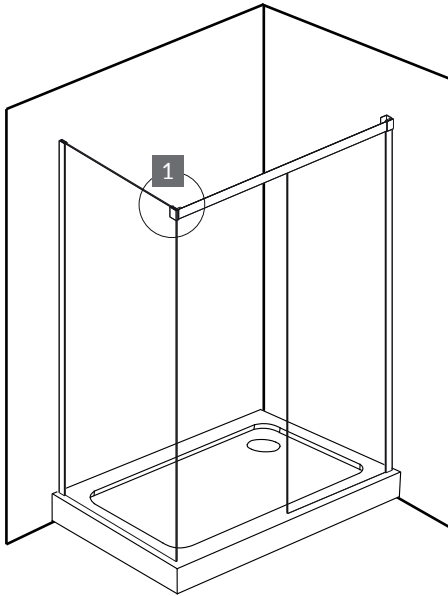
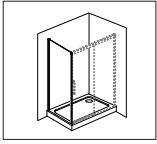

PH2

S  x2

T  x1

V  x2

 x1



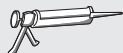
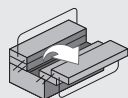
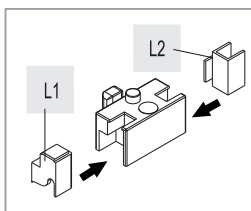
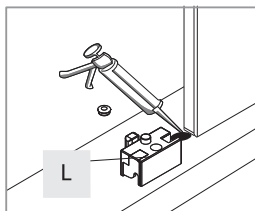
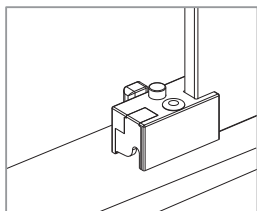
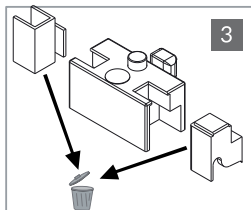
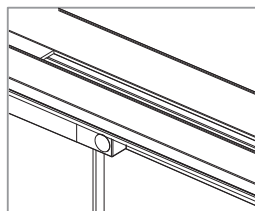
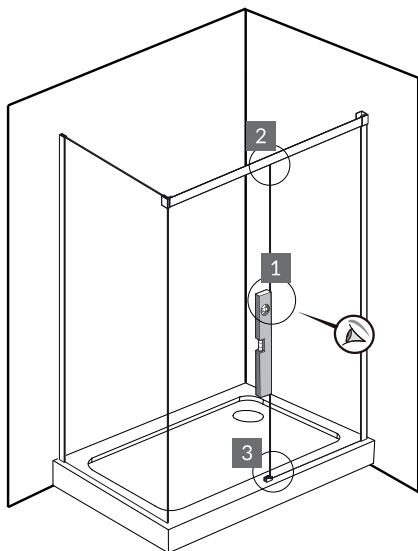
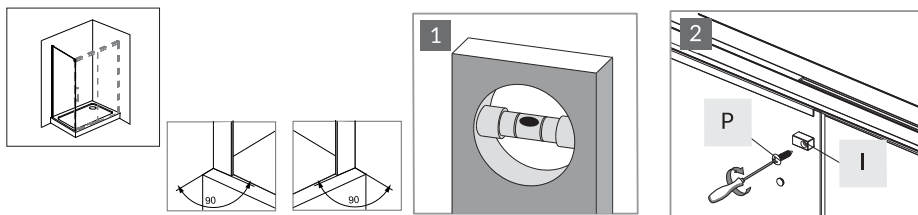

x1



x1



x1



x1



x1



3.5x12 x1



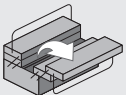
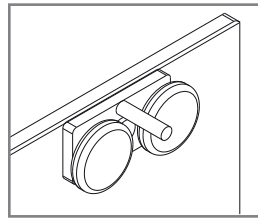
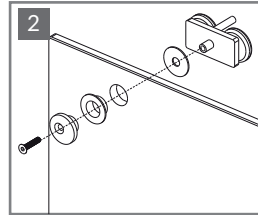
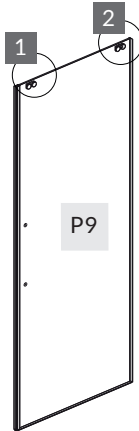
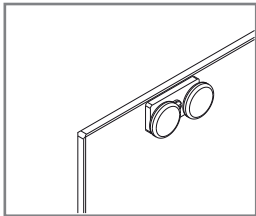
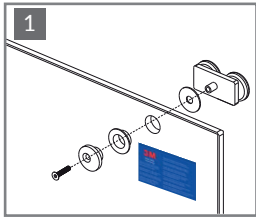
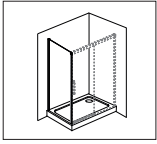

J



x1

K



x1



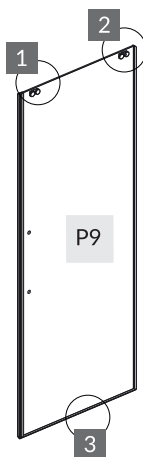
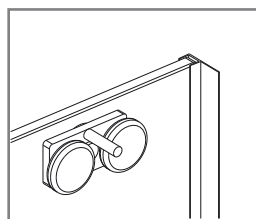
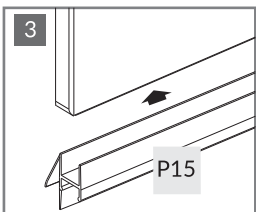
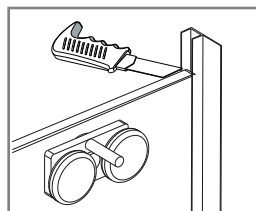
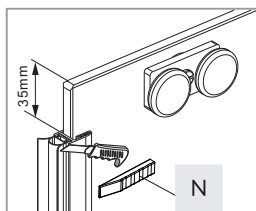
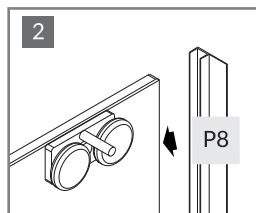
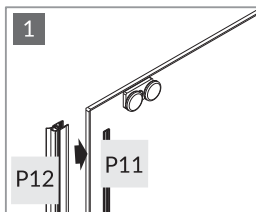
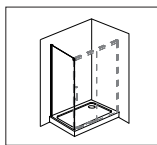

		P12		x1	
		P11		x1	
		P8		x1	
		P15		x1	
		N		x1	



28.

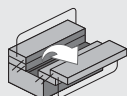
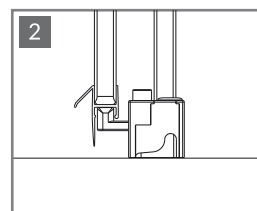
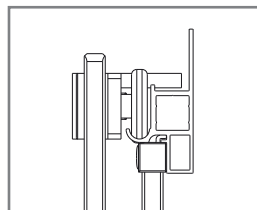
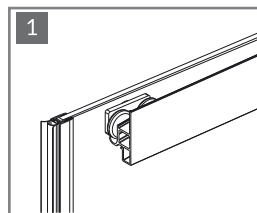
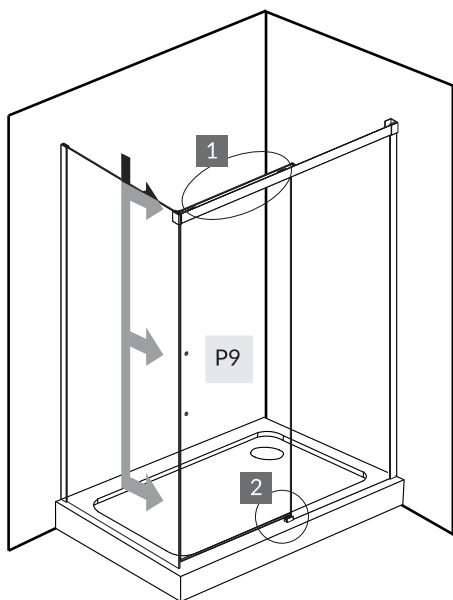
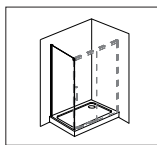

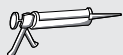
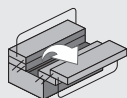
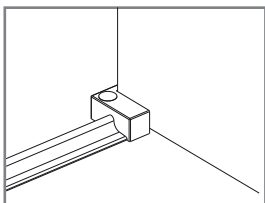
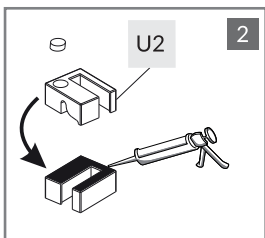
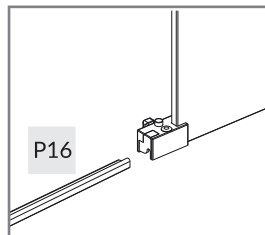
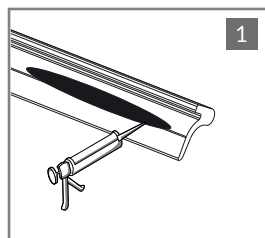
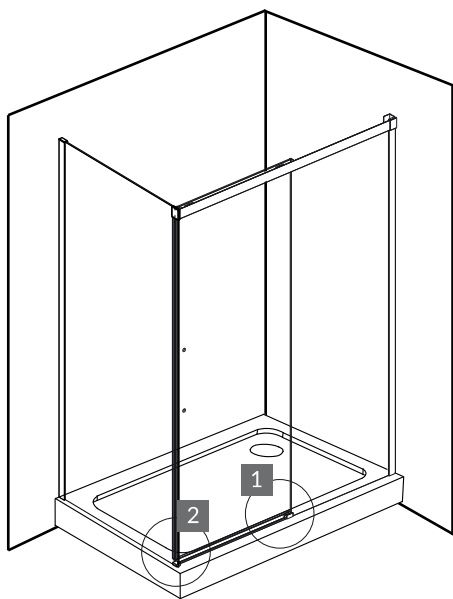
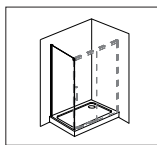

P16 ————— x1

U2  x1



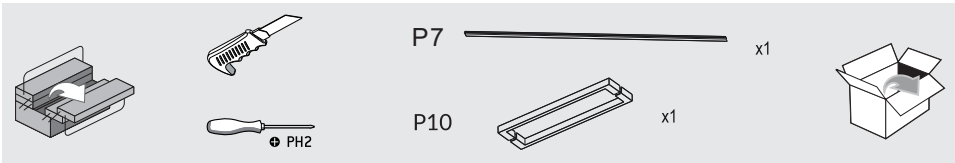
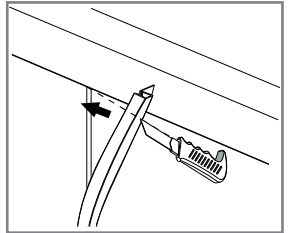
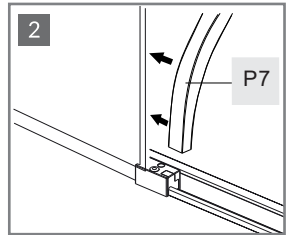
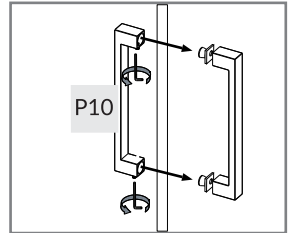
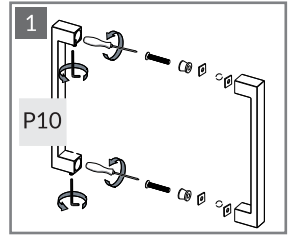
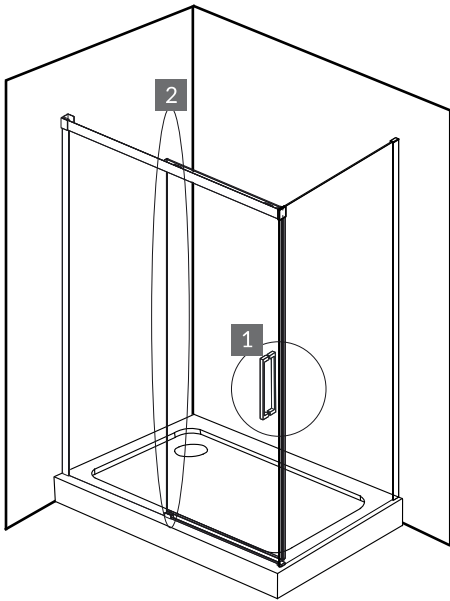

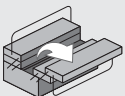
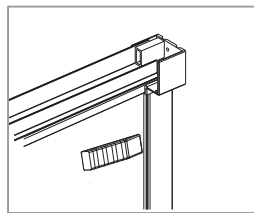
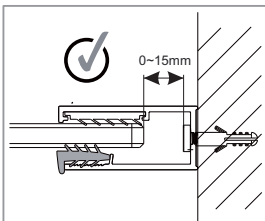
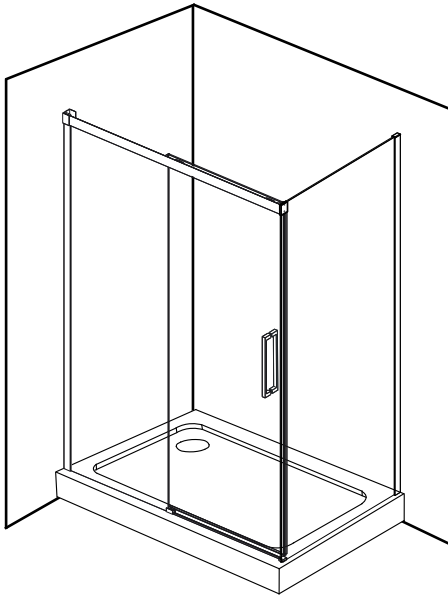
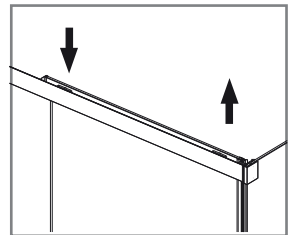
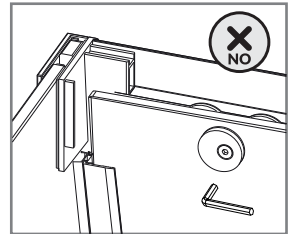
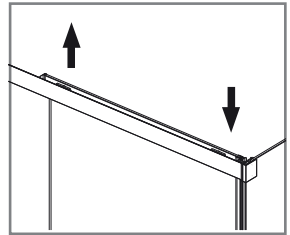
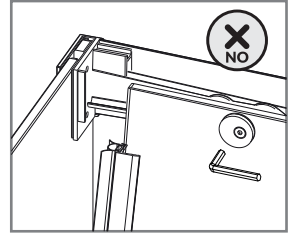
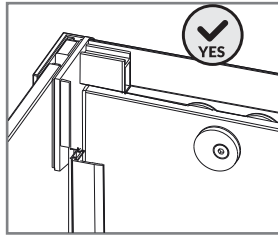

- |   |   |    |
|---|---|----|
| R |  | x1 |
| N |  | x1 |



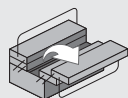
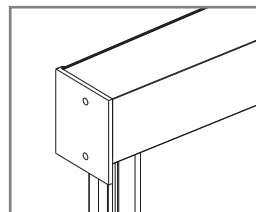
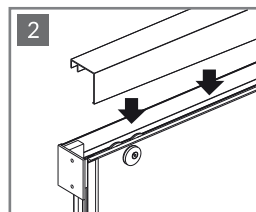
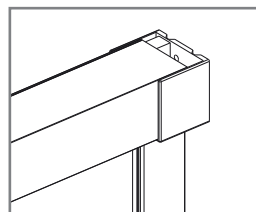
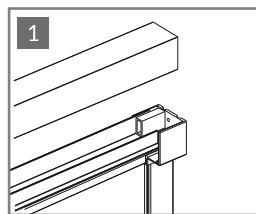
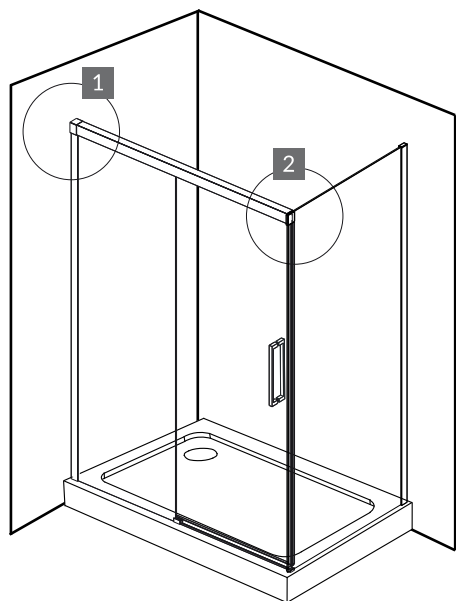

P13



x1



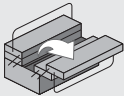
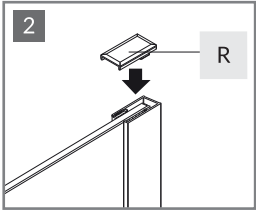
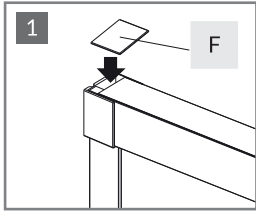
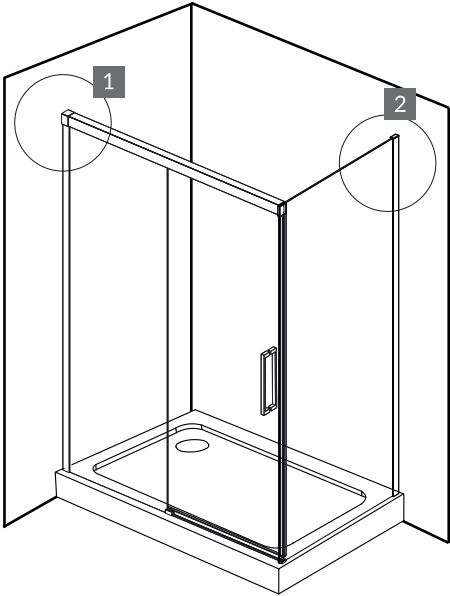

R  x1

F  x1

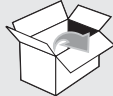

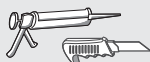
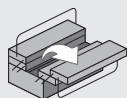
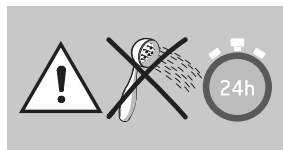
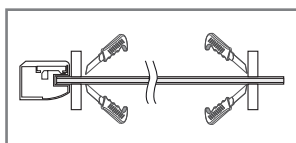
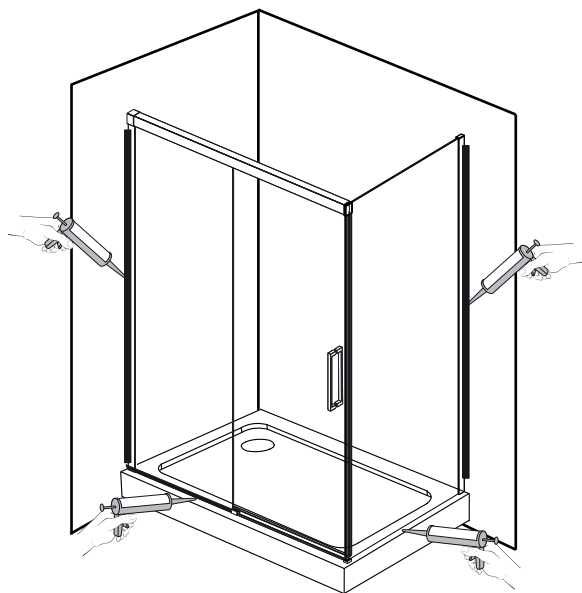



6.5 < PH < 7.5

