

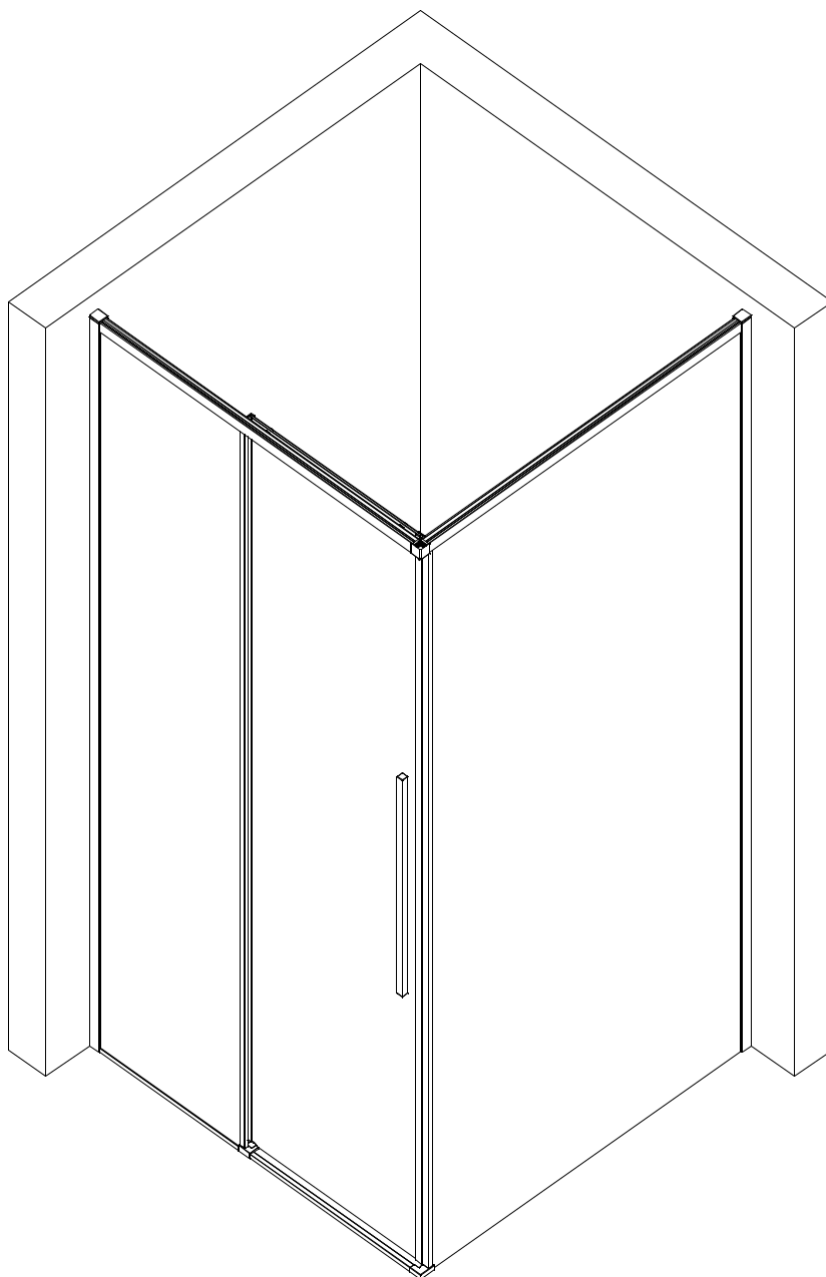

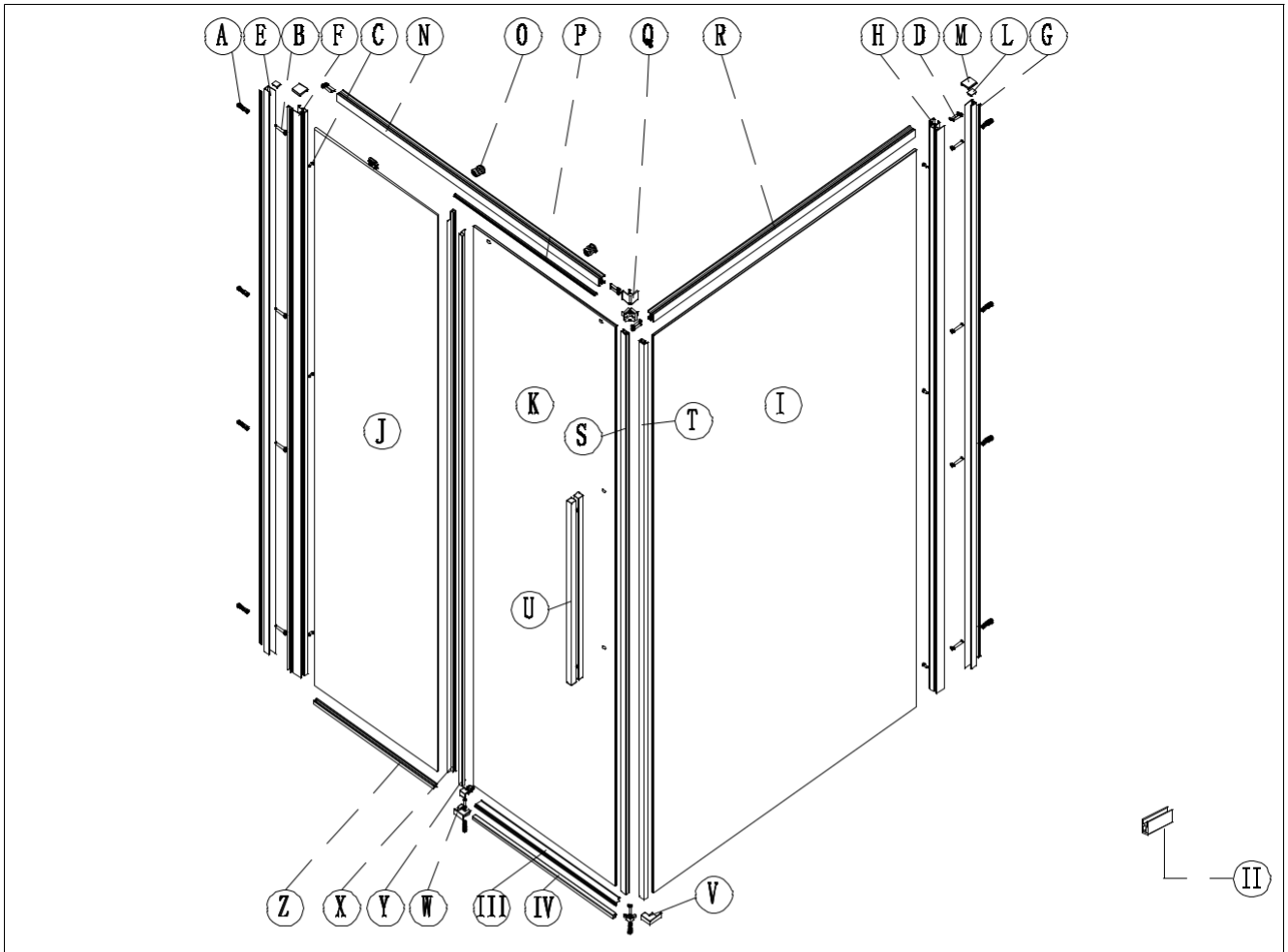















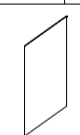
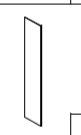
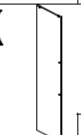

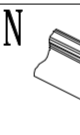

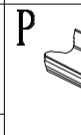
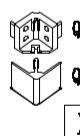
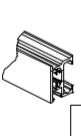
Rea

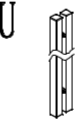
ŁAZIENKA Z WYOBRAŹNIĄ

MONTAŻNÍ NÁVOD REA-K4902

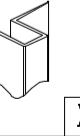
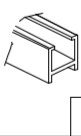
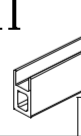
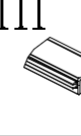
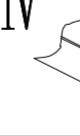
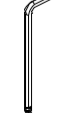
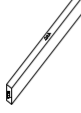
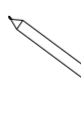

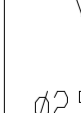
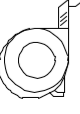

 X10	 ST4. 2x32 X8	 ST3. 5x9. 5 X6	 ST3. 9x32 X8	 X2	 X2	 X2	 X2
	 X1	 X1	 X2	 X2	 X1	 X2	 X1
 q1 q2 X1	 X1	 X1	 X1	 X1	 v1 v2 X1	 v1 v2 X1	 X1
 X1	 X1	 X2	 X1	 X1			
							 Ø2.5
							

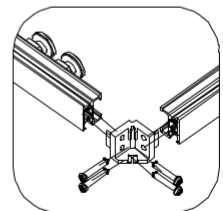
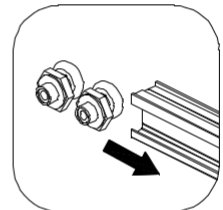
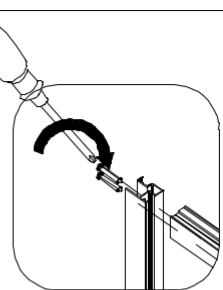
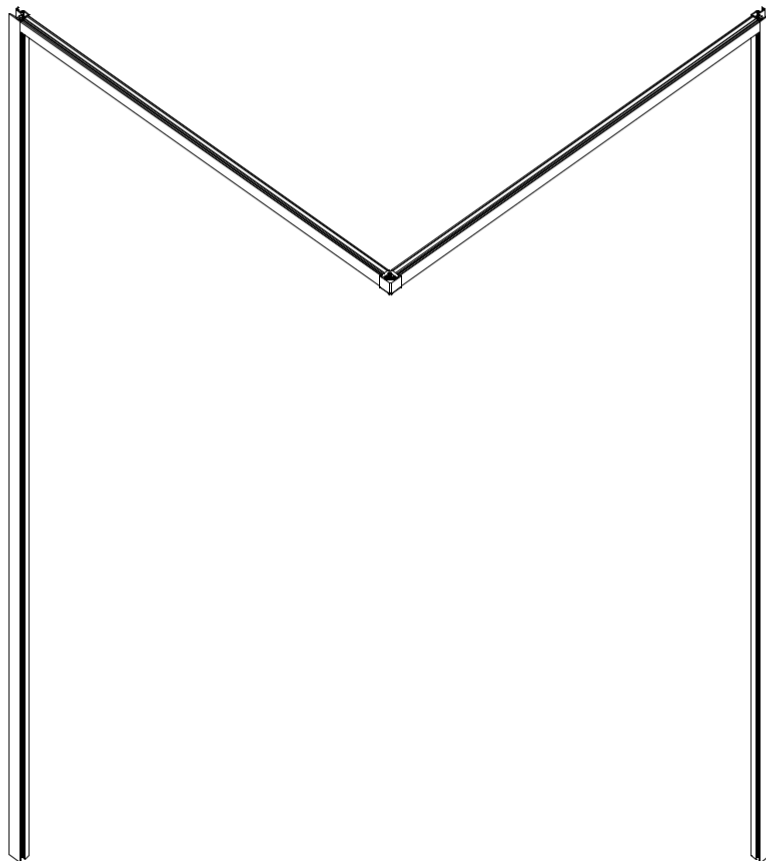
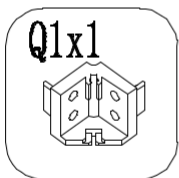
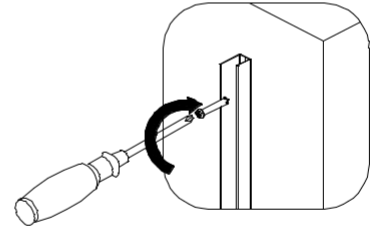
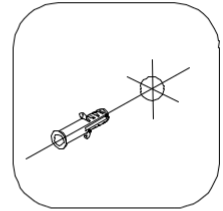
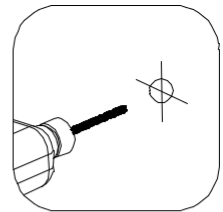
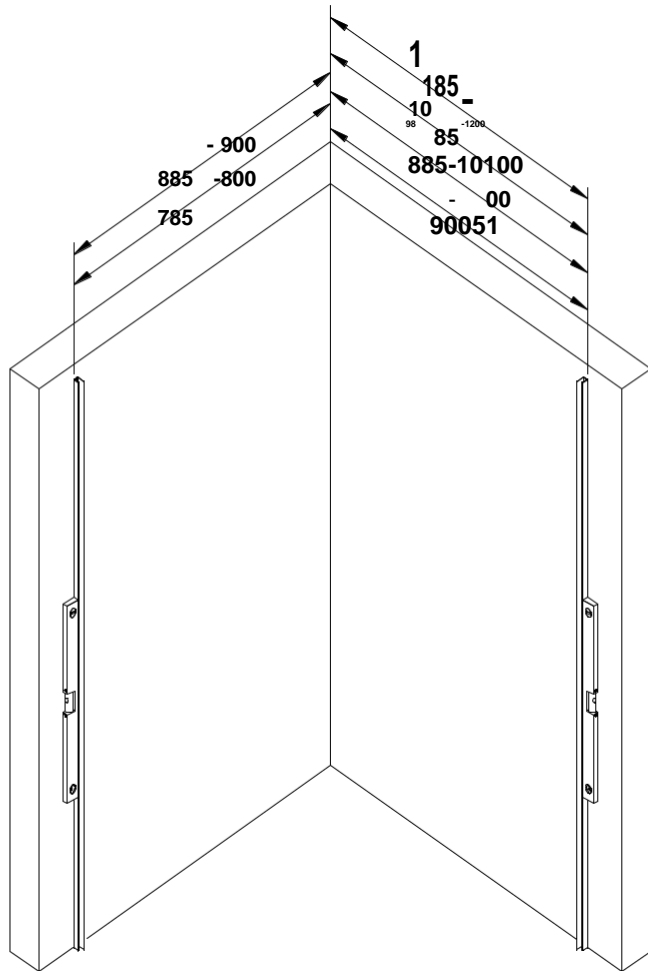

Ax8



Bx8



ST4. 2x32

Fx2



Ix1



Zx1

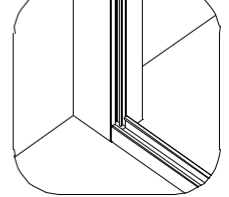
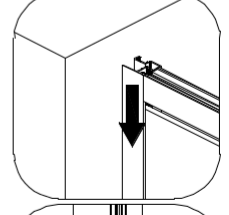
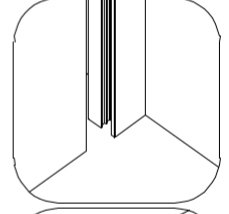
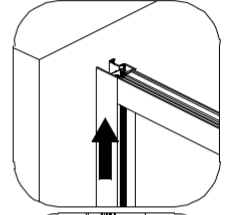
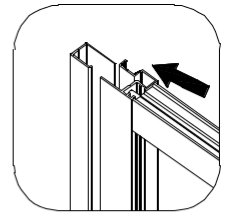
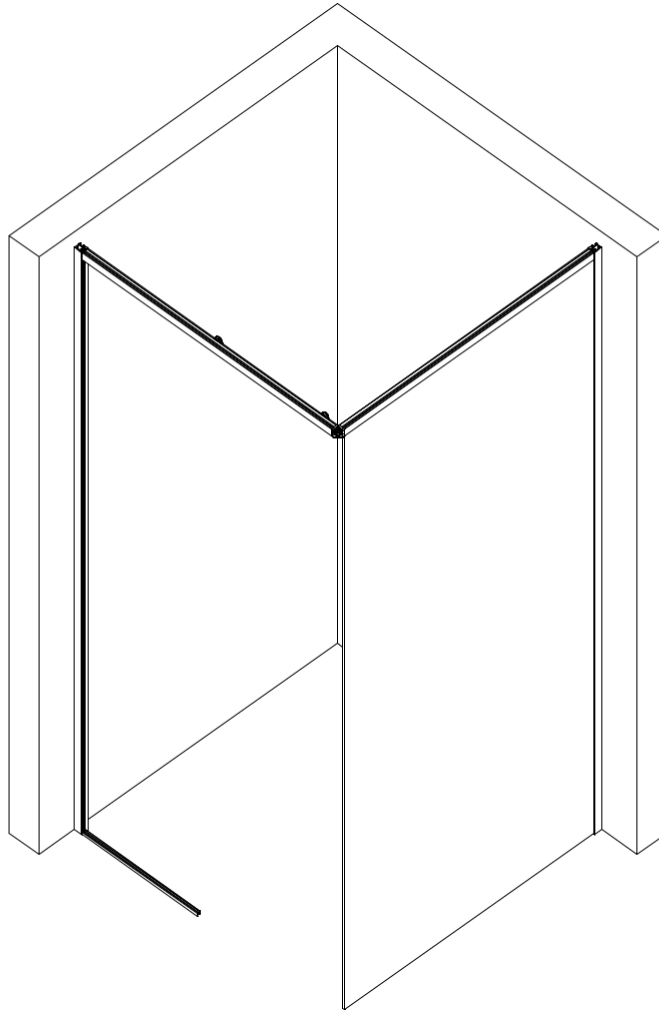

Ax1



Bx1



ST4. 2x32

Gx2



Jx1



Wx1

