

# Rea

ŁAZIENKA Z WYOBRAŻNIĄ

## MONTÁŽNÍ NÁVOD

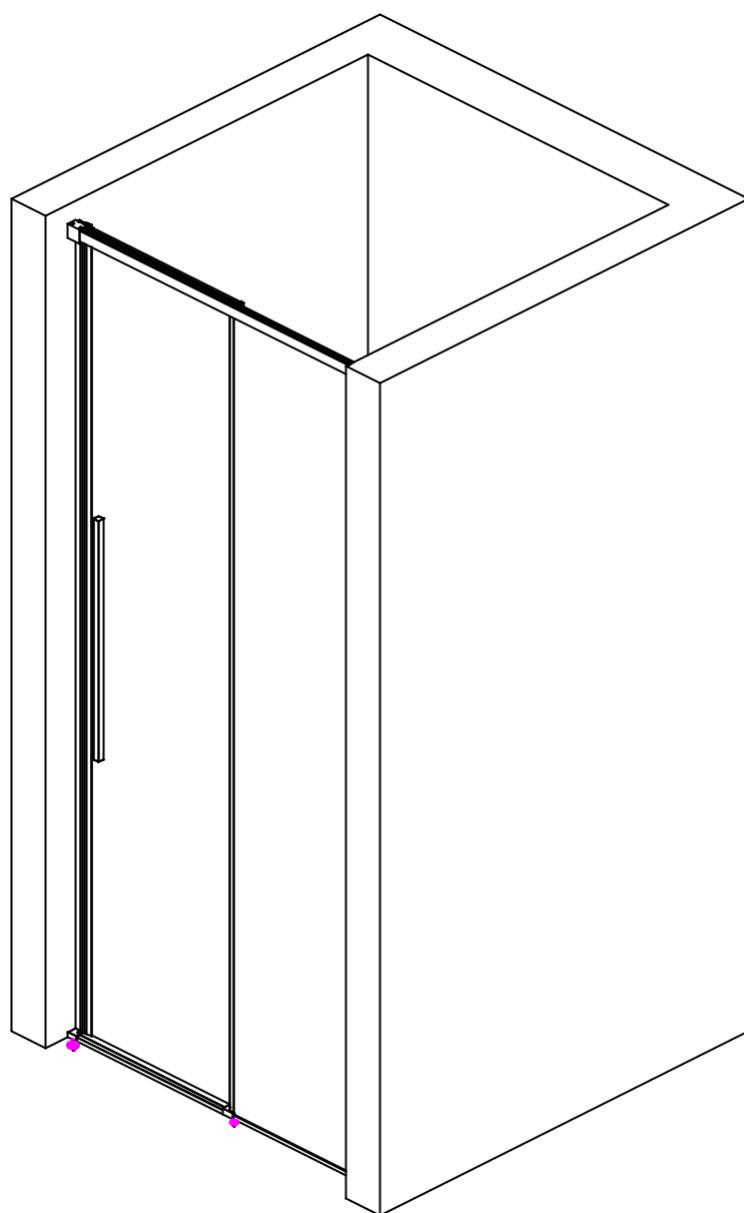

## SPRCHOVÉ DVEŘE GOLD

## VAROVÁNÍ

Nepoužívejte sprchový kout prvních 24 hodin po instalaci, aby silikon mohl úplně zaschnout.

### Obecná informace

Před zahájením montáže zkontrolujte, zda jsou všechny prvky obsažené v návodu obsaženy v obalu a zda nejsou poškozené. V případě poškození nebo chybějících položek kontaktujte neprodleně prodejce.

### UPOZORNĚNÍ: NEINSTALUJTE POŠKOZENÉ KOMPONENTY

a) před zahájením montáže si prosím přečtěte pokyny a zkontrolujte, zda máte požadované nástroje a součásti sprchového koutu. Následujte instrukce.

b) Při montáži nepoužívejte ostré nebo tvrdé nástroje, aby nedošlo k poškození skla. V případě potřeby použijte gumovou paličku.

POZNÁMKA: tvrzené sklo nelze upravovat.









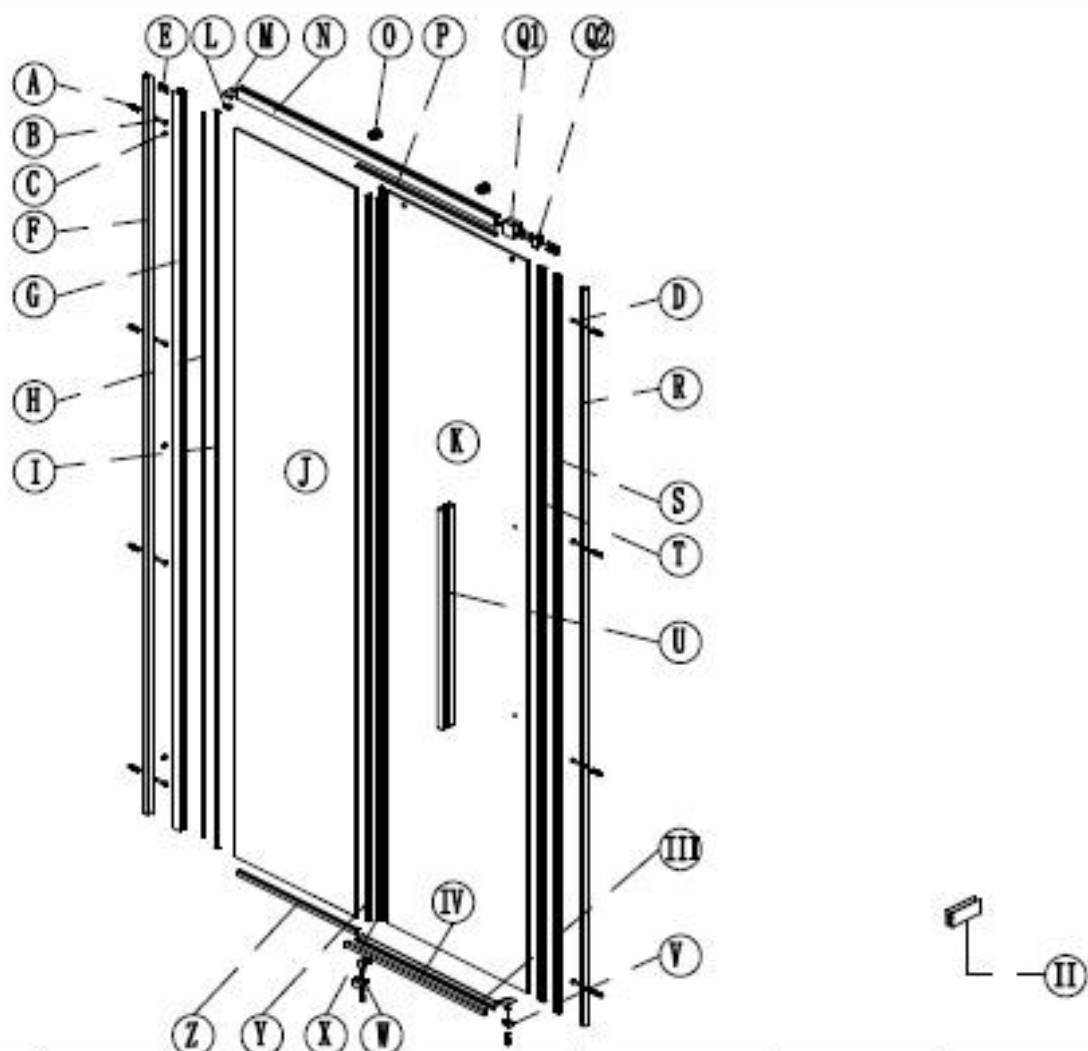



























Při vrtání otvorů do zdi buďte velmi opatrní, abyste se vyhnuli řezání trubek nebo kabelů.

POZNÁMKA: sprchový kout je těžký, může vyžadovat montáž dvěma osobami.

### Čištění a údržba:

Po použití by mělo být sklo omyto mýdlem a vodou. To je zvláště důležité, aby se zabránilo usazování vodního kamene nebo usazenin. Denní čištění lze provádět běžnými čisticími prostředky a měkkým hadříkem. Nedoporučuje se používat prostředky na bázi acetonu a amoniaku, stejně jako ostré houbičky. Vyhněte se prosím kontaktu s vysoce korozivními chemikáliemi, jako jsou rozpouštědla nebo odstraňovače nátěru.



A  X12	B  ST4. 2x32 X8	C  ST3. 5x9. 5 X3	D  ST4. 2x32 X4	E  ST3. 9x32 X2	F  X1	G  X1	H  X1
I  X1	J  X1	K  X1	L  X1	M  X1	N  X1	O  X2	P  X1
Q  X1	R  X1	S  X1	T  X1	U  X1	V  X1	W  X1	X  X1
Y  X1	Z  X1	II  X2	III  X1	IV  X1			
							 Ø2.5
